

DIAGRAMS AND CIRCUIT BOARD ILLUSTRATIONS

Symbols

Graphic symbols and class designation letters are based on ANSI Standard Y32.2-1975.

Logic symbology is based on ANSI Y32.14-1973 in terms of positive logic. Logic symbols depict the logic function performed and may differ from the manufacturer's data.

The overline on a signal name indicates that the signal performs its intended function when it is in the low state.

Abbreviations are based on ANSI Y1.1-1972.

Other ANSI standards that are used in the preparation of diagrams by Tektronix, Inc. are:

- Y14.15, 1966 Drafting Practices.
- Y14.2, 1973 Line Conventions and Lettering.
- Y10.5, 1968 Letter Symbols for Quantities Used in Electrical Science and Electrical Engineering.

American National Standard Institute
1430 Broadway
New York, New York 10018

Component Values

Electrical components shown on the diagrams are in the following units unless noted otherwise:

- Capacitors = Values one or greater are in picofarads (pF). Values less than one are in microfarads (μF).
- Resistors = Ohms (Ω).

The information and special symbols below may appear in this manual.

Assembly Numbers and Grid Coordinates

Each assembly in the instrument is assigned an assembly number (e.g., A20). The assembly number appears on the circuit board outline on the diagram, in the title for the circuit board component location illustration, and in the lookup table for the schematic diagram and corresponding component locator illustration. The Replaceable Electrical Parts list is arranged by assemblies in numerical sequence; the components are listed by component number *(see following illustration for constructing a component number).

The schematic diagram and circuit board component location illustration have grids. A lookup table with the grid coordinates is provided for ease of locating the component. Only the components illustrated on the facing diagram are listed in the lookup table. When more than one schematic diagram is used to illustrate the circuitry on a circuit board, the circuit board illustration may only appear opposite the first diagram on which it was illustrated; the lookup table will list the diagram number of other diagrams that the circuitry of the circuit board appears on.

COLOR CODE

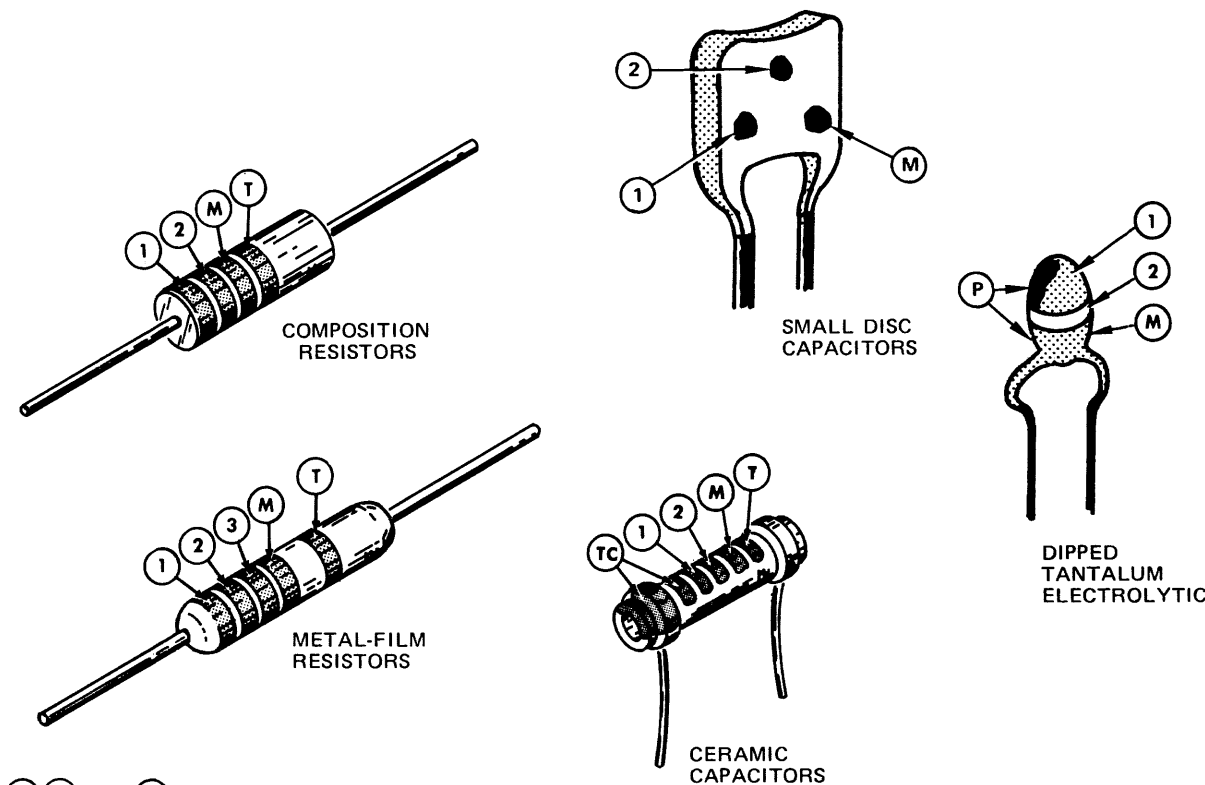

- ① ② and ③ — 1st, 2nd, and 3rd significant figures
- Ⓜ — multiplier Ⓣ — tolerance
- ⓉⓈ — temperature coefficient
- Ⓟ — polarity and voltage rating
- Ⓣ and/or Ⓢ color code may not be present on some capacitors

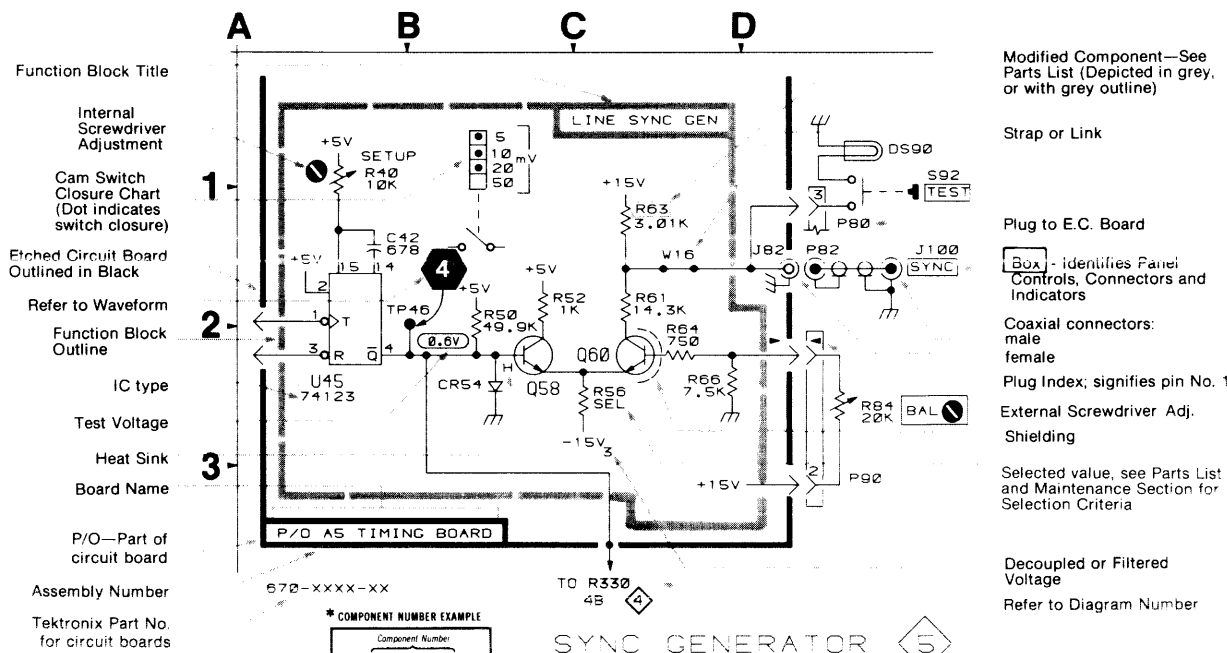

COLOR	SIGNIFICANT FIGURES	RESISTORS		CAPACITORS		DIPPED TANTALUM VOLTAGE RATING
		MULTIPLIER	TOLERANCE	MULTIPLIER	TOLERANCE	
BLACK	0	1	---	1	±20%	4 VDC
BROWN	1	10	±1%	10	±1%	±0.1 pF
RED	2	10 ² or 100	±2%	10 ² or 100	±2%	---
ORANGE	3	10 ³ or 1 K	±3%	10 ³ or 1000	±3%	---
YELLOW	4	10 ⁴ or 10 K	±4%	10 ⁴ or 10,000	+100% -9%	---
GREEN	5	10 ⁵ or 100 K	±5%	10 ⁵ or 100,000	±5%	±0.5 pF
BLUE	6	10 ⁶ or 1 M	±4%	10 ⁶ or 1,000,000	---	---
VIOLET	7	---	±1/10%	---	---	---
GRAY	8	---	---	10 ⁻² or 0.01	+80% -20%	±0.25 pF
WHITE	9	---	---	10 ⁻¹ or 0.1	±10%	±1 pF
GOLD	—	10 ⁻¹ or 0.1	±5%	---	---	---
SILVER	—	10 ⁻² or 0.01	±10%	---	---	---
NONE	—	---	±20%	---	±10%	±1 pF

(1861-20A) 2662-48

Figure 9-1. Color codes for resistors and capacitors.

9-2445 Service
ATIONS

and Lettering.
r Quantities Used in
ce and Electrical

d Institute
018

n the diagrams are in
herwise:

are in picofarads (pF).
are in microfarads

manual.

circuit board component
lookup table with the
ease of locating the
illustrated on the facing
table. When more than
ustrate the circuitry on
illustration may only
on which it was il-
the diagram number of
of the circuit board

Modified Component—See
Parts List (Depicted in grey,
or with grey outline)

Strap or Link

Plug to E.C. Board

Box - Identifies Panel
Controls, Connectors and
Indicators

Coaxial connectors:
male
female

Plug Index; signifies pin No. 1

External Screwdriver Adj.
Shielding

Selected value, see Parts List
and Maintenance Section for
Selection Criteria

Decoupled or Filtered
Voltage

Refer to Diagram Number

Schematic Name
and Number

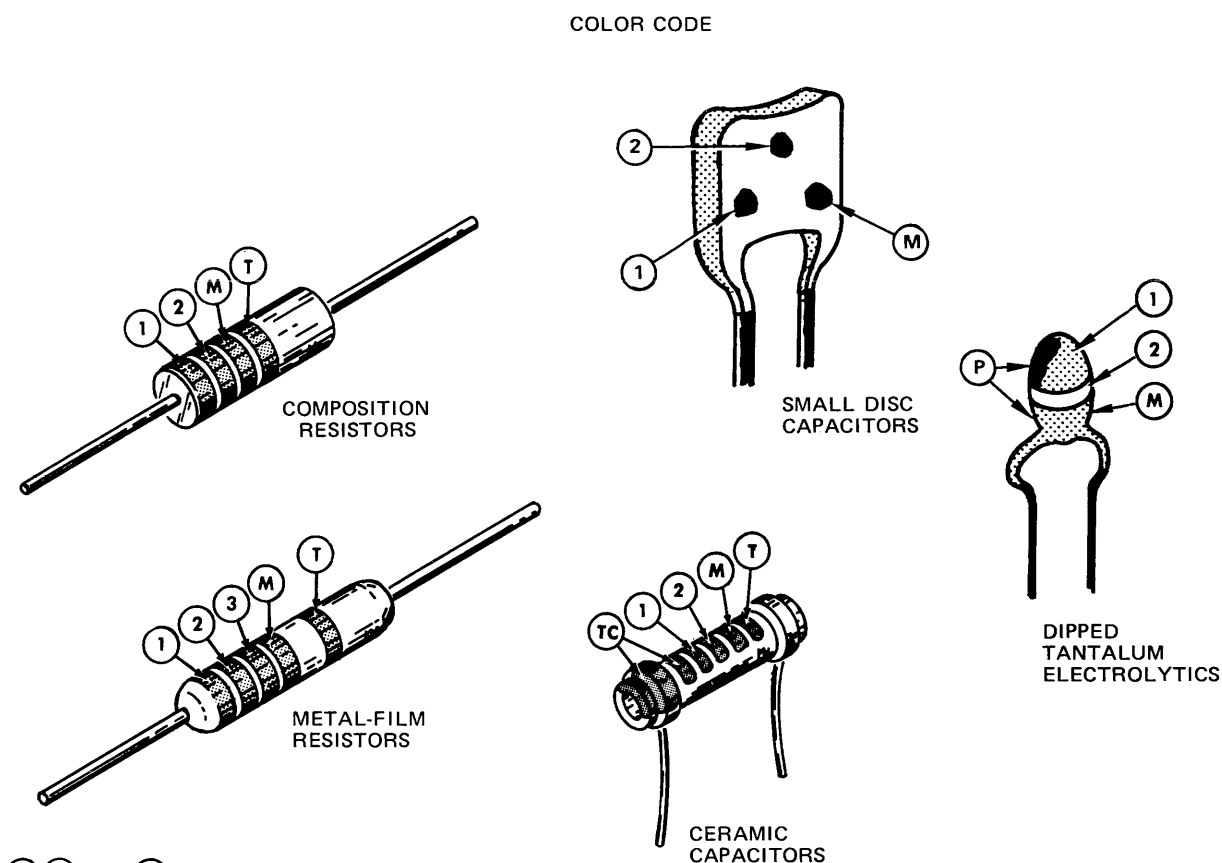

① ② and ③ - 1st, 2nd, and 3rd significant figures
 (M) - multiplier (T) - tolerance
 (TC) - temperature coefficient
 (P) - polarity and voltage rating
 (T) and/or (TC) color code may not be present on some capacitors

COLOR	SIGNIFICANT FIGURES	RESISTORS		CAPACITORS		DIPPED TANTALUM VOLTAGE RATING	
		MULTIPLIER	TOLERANCE	MULTIPLIER	TOLERANCE		
BLACK	0	1	---	1	±20%	±2 pF	4 VDC
BROWN	1	10	±1%	10	±1%	±0.1 pF	6 VDC
RED	2	10 ² or 100	±2%	10 ² or 100	±2%	---	10 VDC
ORANGE	3	10 ³ or 1 K	±3%	10 ³ or 1000	±3%	---	15 VDC
YELLOW	4	10 ⁴ or 10 K	±4%	10 ⁴ or 10,000	+100% -9%	---	20 VDC
GREEN	5	10 ⁵ or 100 K	±½%	10 ⁵ or 100,000	±5%	±0.5 pF	25 VDC
BLUE	6	10 ⁶ or 1 M	±¼%	10 ⁶ or 1,000,000	---	---	35 VDC
VIOLET	7	---	±1/10%	---	---	---	50 VDC
GRAY	8	---	---	10 ⁻² or 0.01	+80% -20%	±0.25 pF	---
WHITE	9	---	---	10 ⁻¹ or 0.1	±10%	±1 pF	3 VDC
GOLD	-	10 ⁻¹ or 0.1	±5%	---	---	---	---
SILVER	-	10 ⁻² or 0.01	±10%	---	---	---	---
NONE	-	---	±20%	---	±10%	±1 pF	---

(1861-20A) 2662-48

Figure 9-1. Color codes for resistors and capacitors.

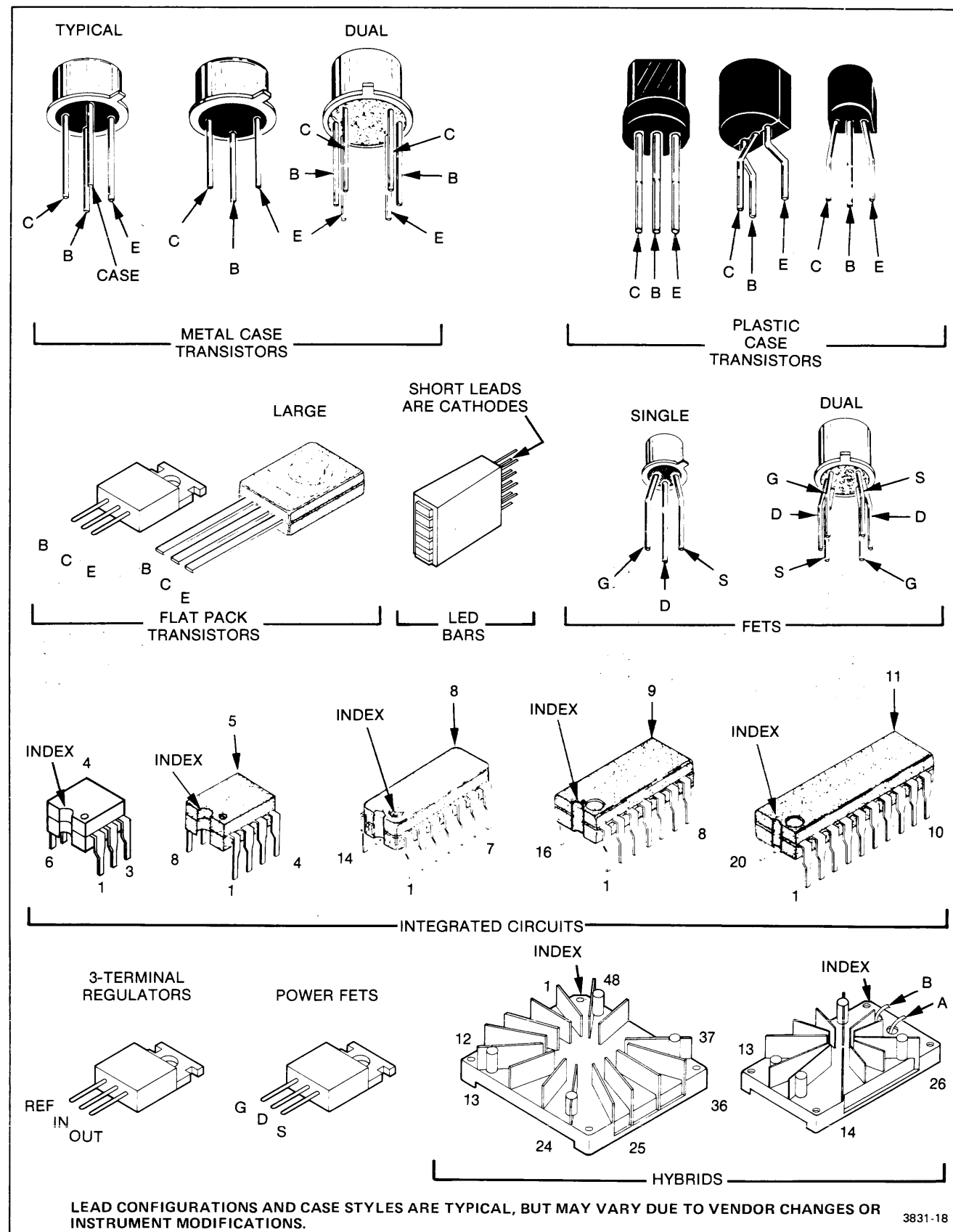

LEAD CONFIGURATIONS AND CASE STYLES ARE TYPICAL, BUT MAY VARY DUE TO VENDOR CHANGES OR INSTRUMENT MODIFICATIONS.

3831-18

Figure 9-2. Semiconductor lead configurations.

2445 Service

To identify any component mounted on a circuit board and to locate that component in the appropriate schematic diagram

EXAMPLE

- 1. Locate the Circuit Board Illustration**
- In the instrument identify the Assembly Number of the circuit board in question. The Assembly Number is usually printed on the upper left corner of the circuit board on the component side.
 - In the manual locate and pull out tabbed page whose title corresponds with the Assembly Number of the circuit board. Circuit board assembly numbers and board nomenclature are printed on the back side of the tabs (facing the rear of the manual).

- 2. Determine the Circuit Number**
- Compare the circuit board with its illustration and locate the desired component by area and shape on the illustration.
 - Scan the table adjacent to the Circuit Board Illustration and find the Circuit Number of the desired component.
 - Determine the Schematic Diagram Number in which the component is located.

- 3. Locate the Component**
- Locate and pull correspond with determined in the schematic diagram and numbers (facing the front of the manual).
 - Scan the Component Location Table for the Assembly Number just determined and find the Circuit Number of the desired component.

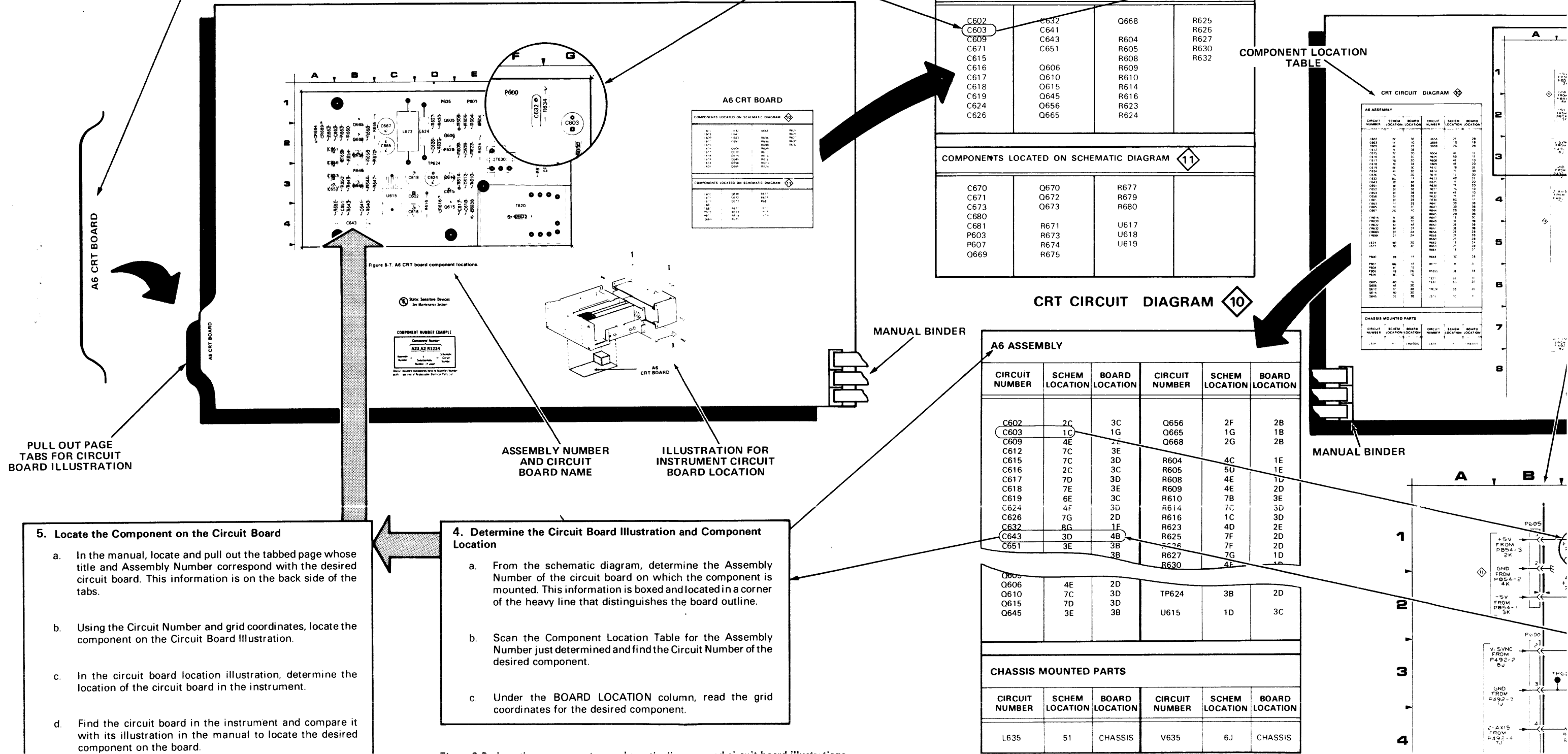

Figure 9-3. Locating components on schematic diagrams and circuit board illustrations.

Determine the Circuit Number

- a. Compare the circuit board with its illustration and locate the desired component by area and shape on the illustration.
- b. Scan the table adjacent to the Circuit Board Illustration and find the Circuit Number of the desired component.
- c. Determine the Schematic Diagram Number in which the component is located.

3. Locate the Component on the Schematic Diagram

- a. Locate and pull out tabbed page whose number and title correspond with the Schematic Diagram Number just determined in the table. Schematic diagram nomenclature and numbers are printed on the front side of the tabs (facing the front of the manual).
- b. Scan the Component Location Table adjacent to the schematic diagram and find the Circuit Number of the desired component.
- c. Under the SCHEM LOCATION column, read the grid coordinates for the desired component.
- d. Using the Circuit Number and grid coordinates, locate the component on the schematic diagram.

A6 CRT BOARD

COMPONENTS LOCATED ON SCHEMATIC DIAGRAM 10

C602	C632	Q668	R625
C603	C641	R626	R626
C609	C643	R627	R627
C615	C651	R608	R630
C616	Q606	R609	R632
C617	Q610	R610	
C618	Q615	R614	
C619	Q645	R616	
C624	Q656	R623	
C626	Q665	R624	

COMPONENTS LOCATED ON SCHEMATIC DIAGRAM 11

C670	Q670	R677	
C671	Q672	R679	
C673	Q673	R680	
C680			
C681	R671	U617	
P603	R673	U618	
P607	R674	U619	
Q669	R675		

COMPONENT LOCATION TABLE

ASSEMBLY

CIRCUIT NUMBER	SCHEM LOCATION	BOARD LOCATION	CIRCUIT NUMBER	SCHEM LOCATION	BOARD LOCATION
C602	2C	3C	Q656	2F	2B
C603	1C	1G	Q665	1G	1B
C609	4E	2E	Q668	2G	2B
C612	7C	3E			
C615	7C	3D	R604	4C	1E
C616	2C	3C	R605	5D	1E
C617	7D	3D	R608	4E	1D
C618	7E	3E	R609	4E	2D
C619	6E	3C	R610	7B	3E
C624	4F	3D	R614	7C	3D
C626	7G	2D	R616	1C	3D
C632	8G	1F	R623	4D	2E
C643	3D	4B	R625	7F	2D
C651	3E	3B	R627	7F	2D
			R627	7G	1D
			R630	4E	1D

CHASSIS MOUNTED PARTS

CIRCUIT NUMBER	SCHEM LOCATION	BOARD LOCATION	CIRCUIT NUMBER	SCHEM LOCATION	BOARD LOCATION
L635	51	CHASSIS	V635	6J	CHASSIS

CRT CIRCUIT DIAGRAM 10

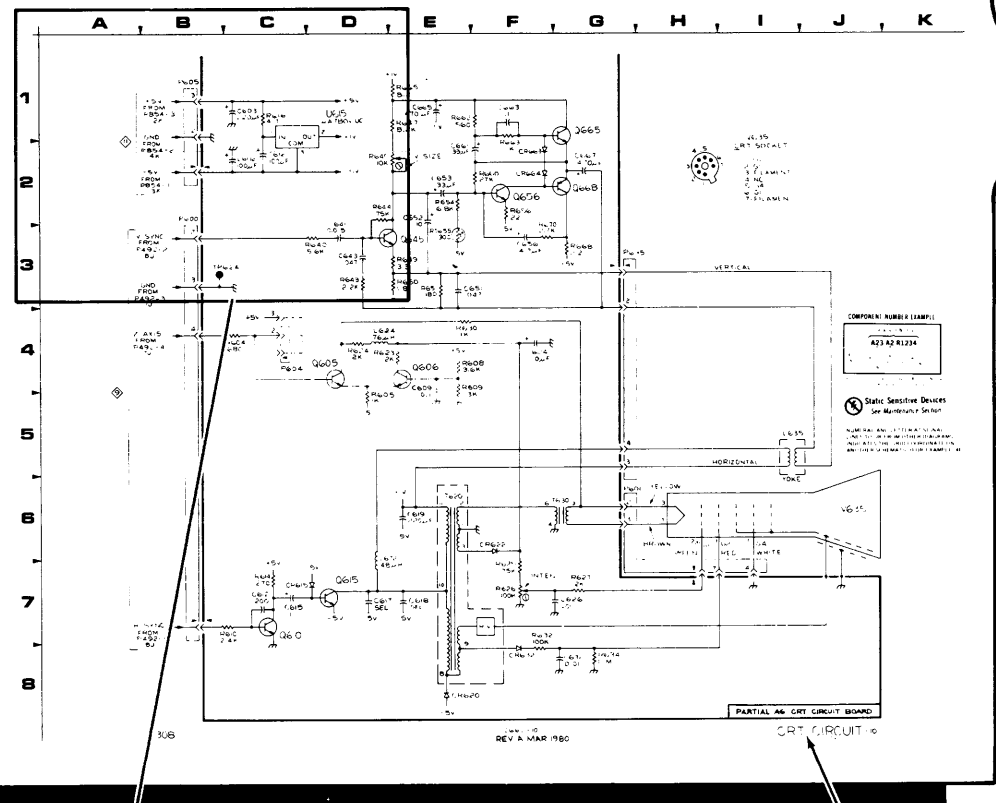

PULL OUT PAGE TABS FOR SCHEMATIC DIAGRAMS

CRT CIRCUIT 10

CRT CIRCUIT 10

SCHEMATIC DIAGRAM NAME AND NUMBER

To identify any component in a schematic diagram and to locate that component on its respective circuit board.

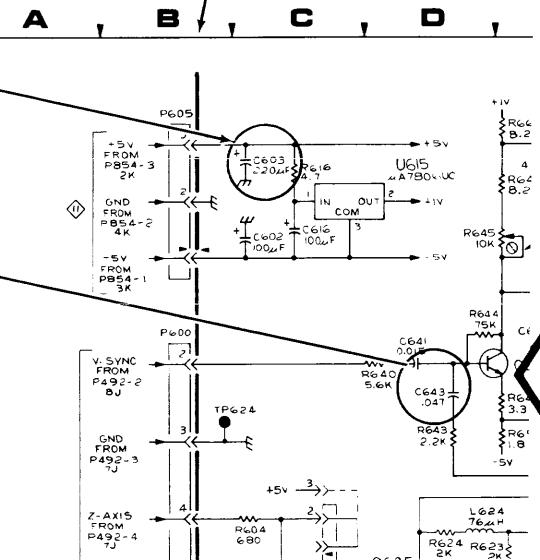

PARTIAL A6 CRT CIRCUIT BOARD

A6 CRT BOARD

COMPONENTS LOCATED ON SCHEMATIC DIAGRAM

L601	F637	Q649	R625
R602	F641	Q649	R626
L604	F643	Q649	R627
L611	F647	Q649	R630
L617	Q606	R609	
L618	Q610	R610	
L619	Q615	R614	
L624	Q645	R616	
L626	Q656	R623	
L630	Q665	R624	

COMPONENTS LOCATED ON SCHEMATIC DIAGRAM

F630	Q630	R671	
L671	Q672	R679	
L672	Q673	R680	
F681			
R681	R671	U617	
R683	R673	U618	
R687	R674	U619	
R689	R675		

A6 ASSEMBLY

CIRCUIT NUMBER	SCHEM LOCATION	BOARD LOCATION	CIRCUIT NUMBER	SCHEM LOCATION	BOARD LOCATION
C602	2C	3C	Q656	2F	2B
C603	1C	1G	Q665	1G	1B
C609	4E	2E	Q668	2G	2B
C612	7C	3E			
C615	7C	3D	R604	4C	1E
C616	2C	3C	R605	5D	1E
C617	7D	3D	R608	4E	1D
C618	7E	3E	R609	4E	2D
C619	6E	3C	R610	7B	3E
C624	4F	3D	R614	7C	3D
C626	7G	2D	R616	1C	3D
C632	8G	1F	R623	4D	2E
C643	3D	4B	R625	7F	2D
C651	3E	3B	R627	7F	2D
			R627	7G	1D
			R630	4E	1D

Q606

Q606	4E	2D	TP624	3B	2D
Q610	7C	3D			
Q615	7D	3D			
Q645	3E	3B	U615	1D	3C

CHASSIS MOUNTED PARTS

CIRCUIT NUMBER	SCHEM LOCATION	BOARD LOCATION	CIRCUIT NUMBER	SCHEM LOCATION	BOARD LOCATION
L635	51	CHASSIS	V635	6J	CHASSIS

MANUAL BINDER

MANUAL BINDER

ILLUSTRATION FOR INSTRUMENT CIRCUIT BOARD LOCATION

Circuit Board Illustration and Component

On the circuit board illustration, determine the Assembly Board on which the component is located. The assembly board location is boxed and located in a corner that distinguishes the board outline.

Scan the Component Location Table for the Assembly Board and find the Circuit Number of the desired component.

Under the SCHEM LOCATION column, read the grid coordinates for the desired component.

Locate the component on schematic diagrams and circuit board illustrations.

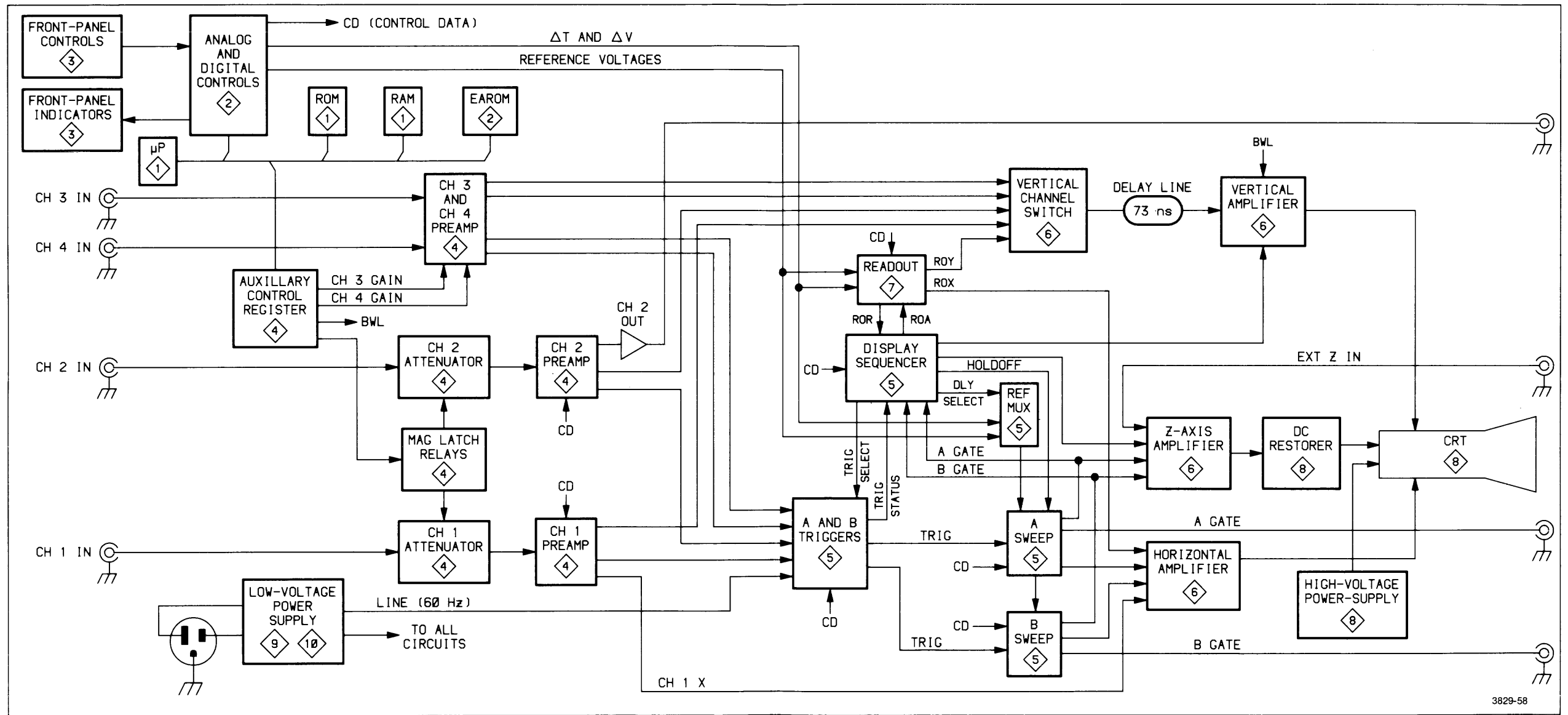
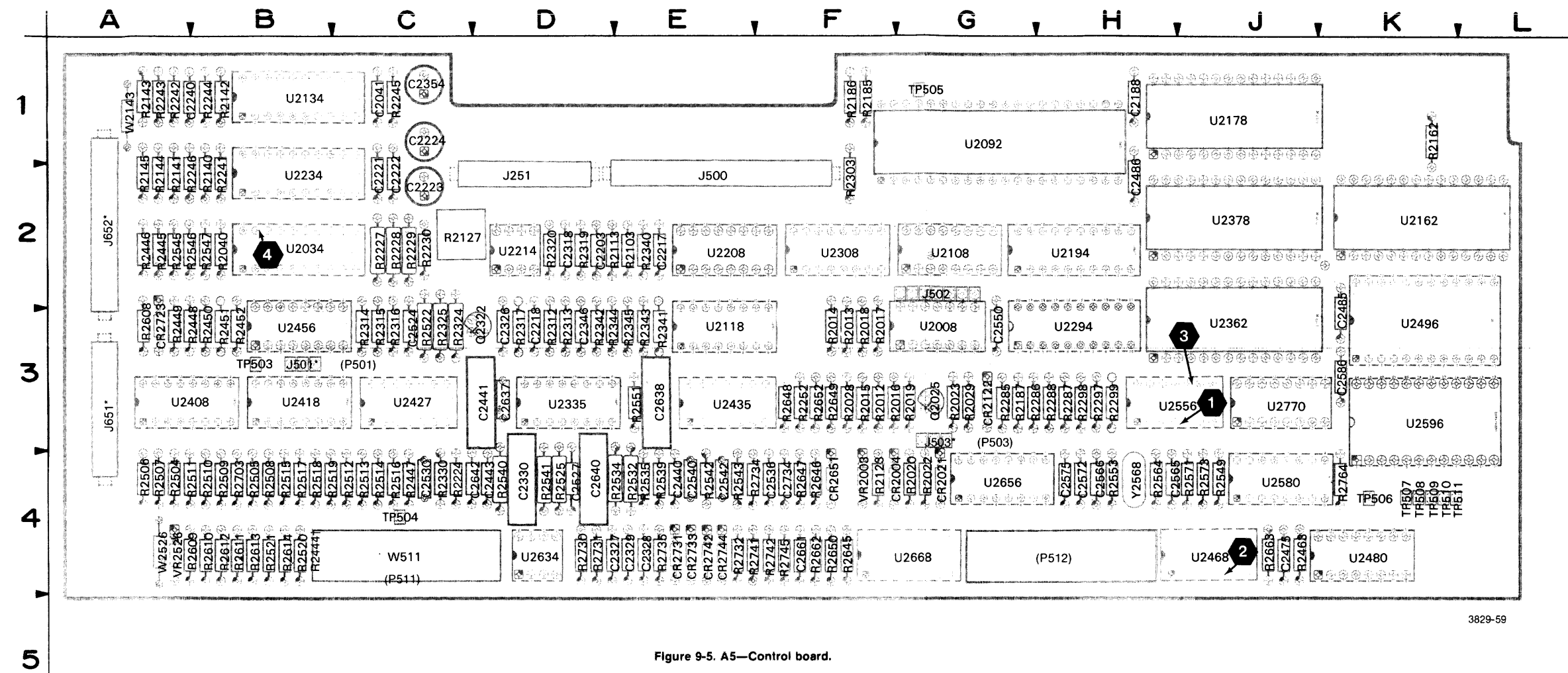

Figure 9-4. 2445 block diagram.



The numbered waveform board dolly. The waveform instrument is running.

3829-59

Figure 9-5. A5—Control board.

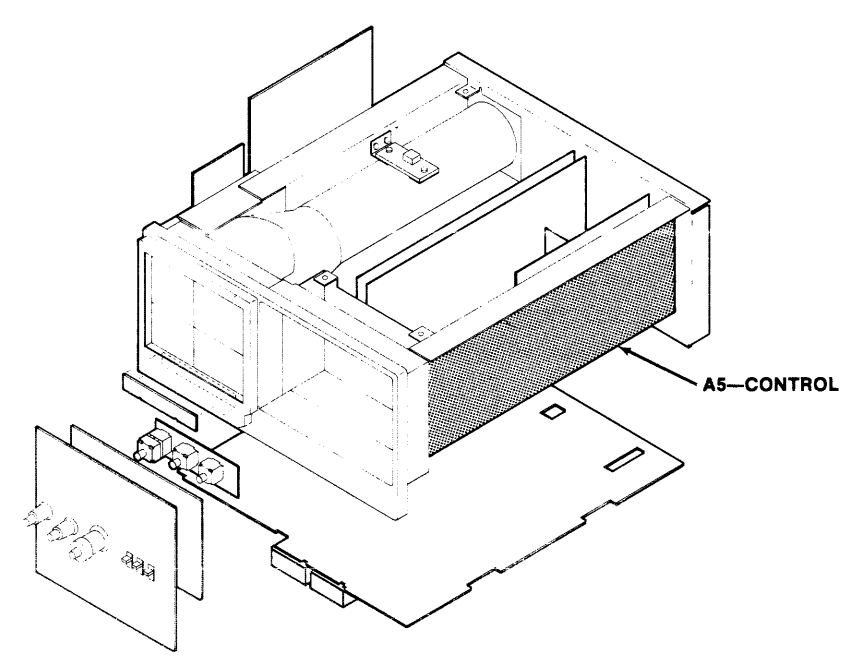

⊗ Static Sensitive Devices
See Maintenance Section

COMPONENT NUMBER EXAMPLE

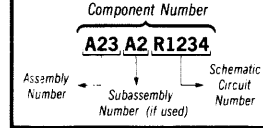

Chassis-mounted components have no Assembly Number prefix—see end of Replaceable Electrical Parts List.

- * LABELED ON SOME BOARDS AS "P" VICE "J".
- () COMPONENTS WITHIN PARENTHESES MAY NOT BE LOCATED PRECISELY AS SHOWN BUT ARE NEAR THEIR INDICATED POSITION.
- † INDICATES COMPONENTS THAT WERE MANUALLY ADDED TO THE BOARD AS A RESULT OF MODIFICATION.

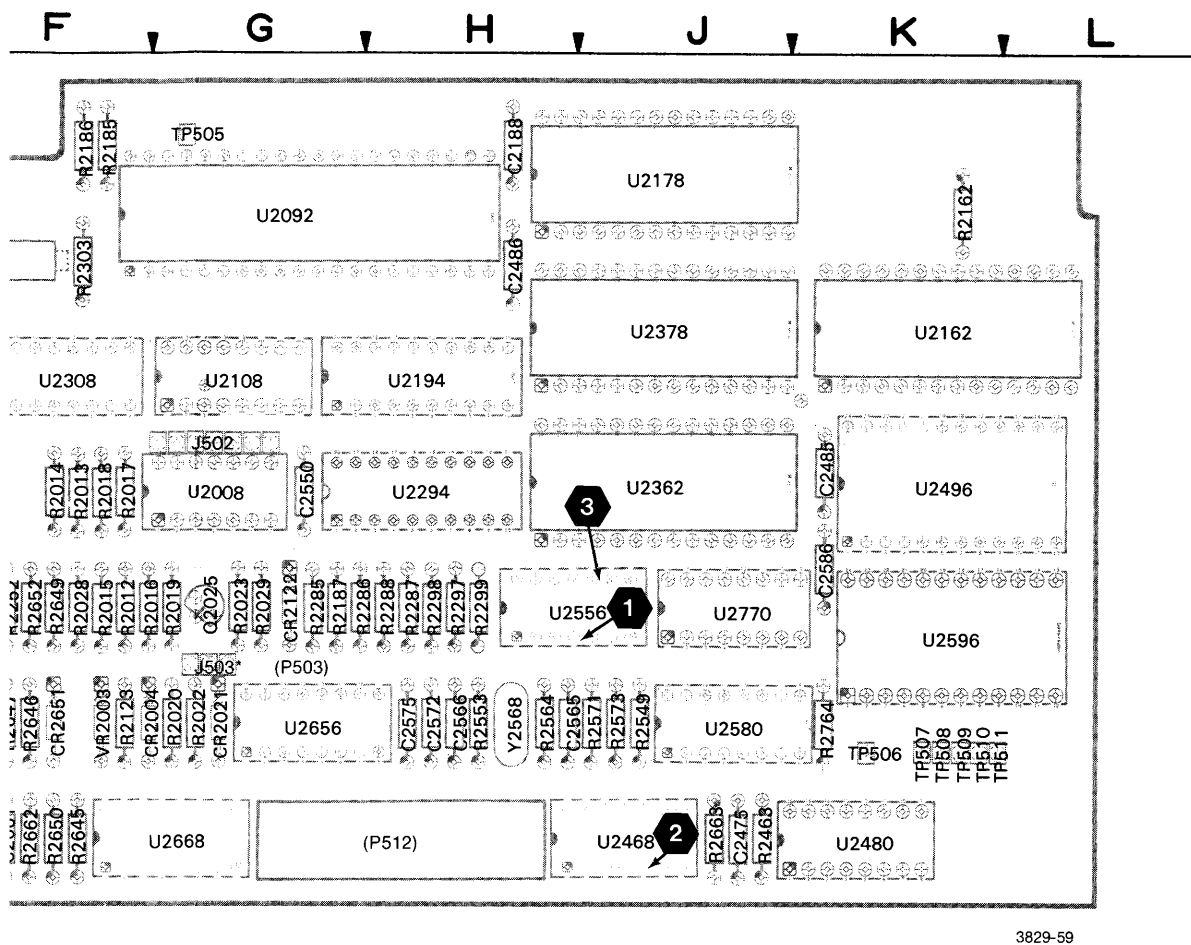

3829-59

oard.

Static Sensitive Devices
See Maintenance Section

COMPONENT NUMBER EXAMPLE

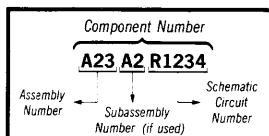

Chassis-mounted components have no Assembly Number prefix—see end of Replaceable Electrical Parts List.

* LABELED ON SOME BOARDS AS "P" VICE "J".

() COMPONENTS WITHIN PARENTHESES MAY NOT BE LOCATED PRECISELY AS SHOWN BUT ARE NEAR THEIR INDICATED POSITION.

† INDICATES COMPONENTS THAT WERE MANUALLY ADDED TO THE BOARD AS A RESULT OF MODIFICATION.

TEST WAVEFORM SETUP INFORMATION

The numbered waveforms below were obtained at the test points indicated on the accompanying schematic diagram and board dolly. The waveforms are representative of signals that may be expected at the associated points whenever the instrument is running.

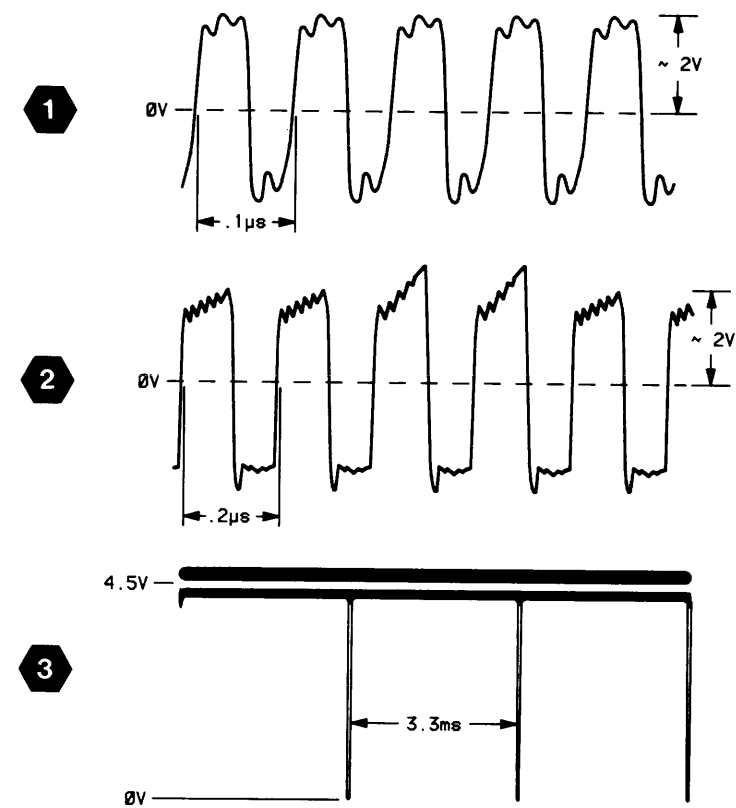

3829-50

A5—CONTROL BOARD

CIRCUIT NUMBER	SCHEM NUMBER	CIRCUIT NUMBER	SCHEM NUMBER	CIRCUIT NUMBER	SCHEM NUMBER	CIRCUIT NUMBER	SCHEM NUMBER	CIRCUIT NUMBER	SCHEM NUMBER
C2041	12	P503	1	R2317	2	R2614	2	U2362	1
C2188	12	P511	2	R2319	2	R2645	1	U2362	12
C2203	1	P511	2	R2320	2	R2646	1	U2378	1
C2217	12	P511	2	R2324	2	R2647	1	U2378	12
C2218	12	P511	12	R2325	2	R2648	1	U2408	2
C2221	12	P512	1	R2330	2	R2649	1	U2408	12
C2222	2	P512	2	R2340	2	R2650	1	U2418	2
C2223	12	P512	2	R2341	2	R2652	1	U2418	12
C2224	2	P512	2	R2342	2	R2662	1	U2427	2
C2240	12	P512	12	R2343	2	R2663	1	U2427	2
C2318	2	Q2025	2	R2344	2	R2703	2	U2427	2
C2326	2	Q2322	2	R2345	2	R2730	2	U2427	2
C2327	2	R2012	2	R2444	2	R2731	2	U2427	12
C2328	12	R2013	2	R2445	2	R2732	2	U2435	1
C2329	2	R2014	2	R2446	2	R2734	2	U2435	2
C2330	2	R2015	2	R2447	2	R2735	2	U2435	2
C2346	12	R2016	2	R2448	2	R2741	2	U2435	2
C2354	12	R2017	2	R2449	2	R2742	2	U2435	12
C2440	12	R2018	2	R2450	2	R2745	2	U2456	2
C2441	2	R2019	2	R2451	2	R2764	1	U2456	12
C2443	2	R2020	2	R2452	2	TP503	2	U2468	1
C2475	12	R2022	2	R2463	1	TP504	2	U2468	1
C2485	12	R2023	2	R2504	2	TP505	1	U2468	12
C2486	1	R2028	2	R2505	2	TP506	1	U2480	1
C2524	2	R2029	2	R2506	2	TP507	1	U2480	12
C2527	12	R2040	2	R2507	2	TP508	12	U2496	1
C2530	2	R2103	2	R2508	2	TP509	1	U2496	12
C2536	2	R2113	2	R2509	2	TP510	1	U2556	1
C2540	2	R2123	2	R2510	2	TP511	1	U2556	1
C2542	2	R2127	2	R2511	2	U2008	2	U2556	1
C2550	1	R2140	2	R2512	2	U2008	2	U2556	1
C2565	1	R2141	2	R2513	2	U2034	2	U2556	1
C2566	1	R2142	2	R2514	2	U2034	12	U2556	1
C2572	1	R2143	2	R2515	2	U2092	1	U2556	12
C2575	12	R2144	2	R2516	2	U2092	12	U2580	1
C2586	12	R2145	2	R2517	2	U2108	2	U2580	12
C2637	12	R2162	1	R2518	2	U2108	12	U2596	1
C2638	2	R2185	1	R2519	2	U2118	1	U2596	12
C2640	2	R2186	1	R2520	2	U2118	2	U2634	2
C2642	12	R2187	1	R2521	2	U2118	2	U2634	2
C2661	1	R2224	2	R2522	2	U2118	2	U2634	12
C2734	12	R2227	2	R2525	2	U2118	2	U2656	1
CR2004	2	R2228	2	R2532	2	U2118	2	U2656	1
CR2021	2	R2229	2	R2534	2	U2118	2	U2656	1
CR2122	2	R2230	2	R2535	2	U2118	2	U2656	1
CR2651	1	R2241	2	R2539	2	U2134	2	U2656	12
CR2723	2	R2242	2	R2540	2	U2134	12	U2668	1
CR2731	2	R2243	2	R2541	2	U2162	1	U2668	12
CR2733	2	R2244	2	R2542	2	U2162	12	U2770	1
CR2742	2	R2245	2	R2543	2	U2178	1	U2770	12
CR2744	2	R2246	2	R2545	2	U2178	12	VR2003	2
J251	1	R2252	1	R2546	2	U2194	1	VR2526	2
J251	12	R2285	1	R2547	2	U2194	1	W511	2
J500	1	R2286	1	R2549	1	U2208	1	W511	2
J500	1	R2287	1	R2551	1	U2208	2	W511	2
J500	1	R2288	1	R2553	1	U2214	2	W511	12
J501	2	R2297	1	R2564	1	U2214	12	W512	1
J502	2	R2298	1	R2571	1	U2234	2	W512	2
J503	1	R2299	1	R2573	1	U2234	12	W512	2
J651	2	R2303	2	R2608	12	U2294	1	W512	2
J651	2	R2312	2	R2609	2	U2294	1	W512	12
J651	2	R2313	2	R2610	2	U2308	2	W2143	12
J652	2	R2314	2	R2611	2	U2308	12	W2526	12
J652	2	R2315	2	R2612	2	U2335	2	Y2568	1
P501	2	R2316	2	R2613	2	U2335	12		

TEST WAVEFORM SETUP INFORMATION

The waveform below was obtained at the test point indicated on the accompanying schematic diagram. The waveform is representative of the signal that may be expected at the test point whenever the instrument is running.

Also shown below is an illustration depicting timing of the D to A Converter and the output ranges that may be expected as the DAC sets up the various analog reference voltages. Test point locations and setup information are called out on the illustration.

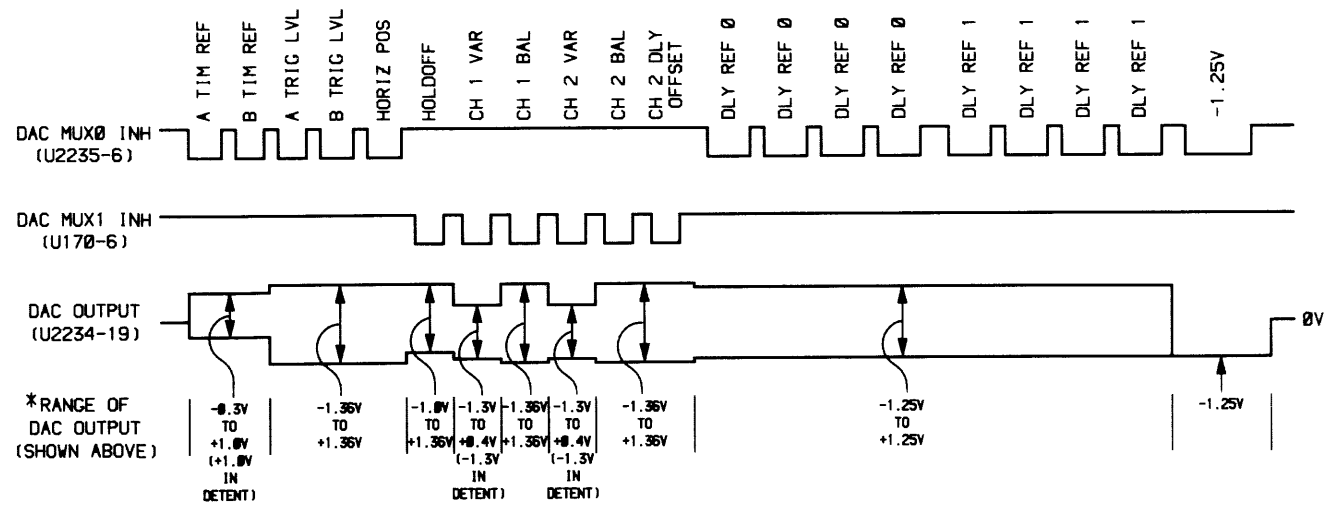
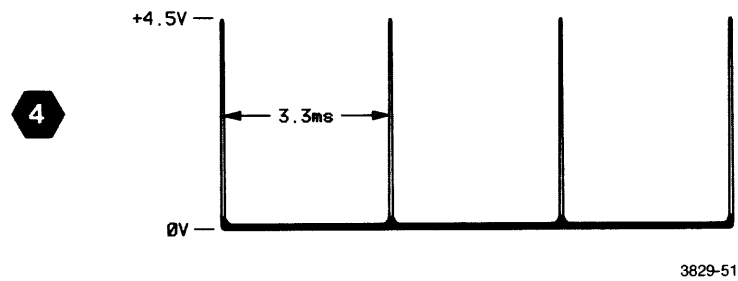

*NOTE: AS ANY GIVEN CONTROL IS EXERCISED, THE CORRESPONDING PORTION OF THE DAC OUTPUT WAVEFORM SHOULD VARY WITHIN THE LIMITS INDICATED.

PROCESSOR AND DIGITAL CONTROL DIAGRAM

1

ASSEMBLY A5								
CIRCUIT NUMBER	SCHEM LOCATION	BOARD LOCATION	CIRCUIT NUMBER	SCHEM LOCATION	BOARD LOCATION	CIRCUIT NUMBER	SCHEM LOCATION	BOARD LOCATION
C2203	6C	2D	R2299	9A	3H	U2194	7B	2H
C2486	6C	2H	R2463	4C	4J	U2194	9C	2H
C2550	6C	3G	R2549	4C	4J	U2208	7C	2E
C2565	4C	4H	R2551	5N	3E	U2294	7B	3H
C2566	4B	4H	R2553	4B	4H	U2294	9D	3H
C2572	3B	4H	R2564	4C	4H	U2362	8H	3J
C2661	6A	4F	R2571	3B	4J	U2378	8F	2J
			R2573	3B	4J	U2435C	6B	3E
CR2651	6B	4F	R2645	5D	4F	U2468A	4D	4J
			R2646	5B	4F	U2468B	2E	4J
J251	5A	2D	R2647	5B	4F	U2480	5G	4K
J500	1P	2E	R2648	5B	3F	U2496	8K	3K
J500	4A	2E	R2649	5C	3F	U2556A	4B	3J
J500	8P	2E	R2650	6C	4F	U2556B	4C	3J
J503	6B	3G	R2652	5A	3F	U2556C	4F	3J
			R2662	6P	4F	U2556D	3B	3J
P503	6B	3G	R2663	4G	4J	U2556E	3H	3J
P512	4P	4H	R2764	3D	4K	U2556F	3F	3J
						U2580	4K	4J
R2162	6H	1K	TP505	4E	1G	U2596	5M	3K
R2185	4B	1F	TP506	5G	4K	U2656A	6C	4G
R2186	5D	1F	TP507	5H	4K	U2656B	5N	4G
R2187	9B	3G	TP509	5H	4K	U2656C	3G	4G
R2252	7B	3F	TP510	5H	4K	U2656D	5N	4G
R2285	8A	3G	TP511	5H	4K	U2668	3H	4G
R2286	9A	3H				U2770	4H	3J
R2287	9B	3H	U2092	5D	1G			
R2288	8B	3H	U2118A	7B	3E	W512	7P	4H
R2297	9B	3H	U2162	6H	2K			
R2298	8A	3H	U2178	6F	1J	Y2568	4B	4H

Partial A5 also shown on diagrams 2 and 12.

ACRONYM DICTIONARY

The following listing explains some of the less obvious acronyms and signal labels used on this schematic. Acronyms and labels not shown in this listing may be included in the circuit descriptions (Section 3) and should be obvious if a little thought is given to the intended circuit function.

- ATTN CLK . . . attenuator clock
- A0 - A15 . . . address bits 0 - 15
- A000H . . . address block A000 hex
- BA . . . bus available
- BD0 - BD7 . . . buffered data bits 0 - 7
- C000H . . . address block C000 hex
- DAC MUX0 INH . . . DAC multiplexer 0 inhibit
- DAC MUX1 INH . . . DAC multiplexer 1 inhibit
- D0 - D7 . . . data bits 0 - 7
- E . . . enable
- \bar{E} . . . enable
- EXTAL . . . external crystal
- E000H . . . address block E000 hex
- GND C . . . virtual ground "C"
- IRQ . . . interrupt request
- LED CLK . . . LED clock
- MR . . . memory ready
- NMI . . . non-maskable interrupt
- PORT 3 INH . . . port 3 inhibit
- RE . . . RAM enable
- ROSFAME . . . readout subframe
- ROS1 (900H) . . . readout strobe 1 (address 0900 hex)
- ROS2 (940H) . . . readout strobe 2 (address 0940 hex)
- R/W . . . read/write
- R/W DLY'D . . . read/write delayed
- TRIG STAT STRB . . . trigger status strobe
- VMA . . . valid memory address
- XTAL . . . crystal
- 0000H . . . address block 0000 hex
- 8000H . . . address block 8000 hex
- 9C1H - 9CFH . . . addresses 09C1 hex - 09CF hex

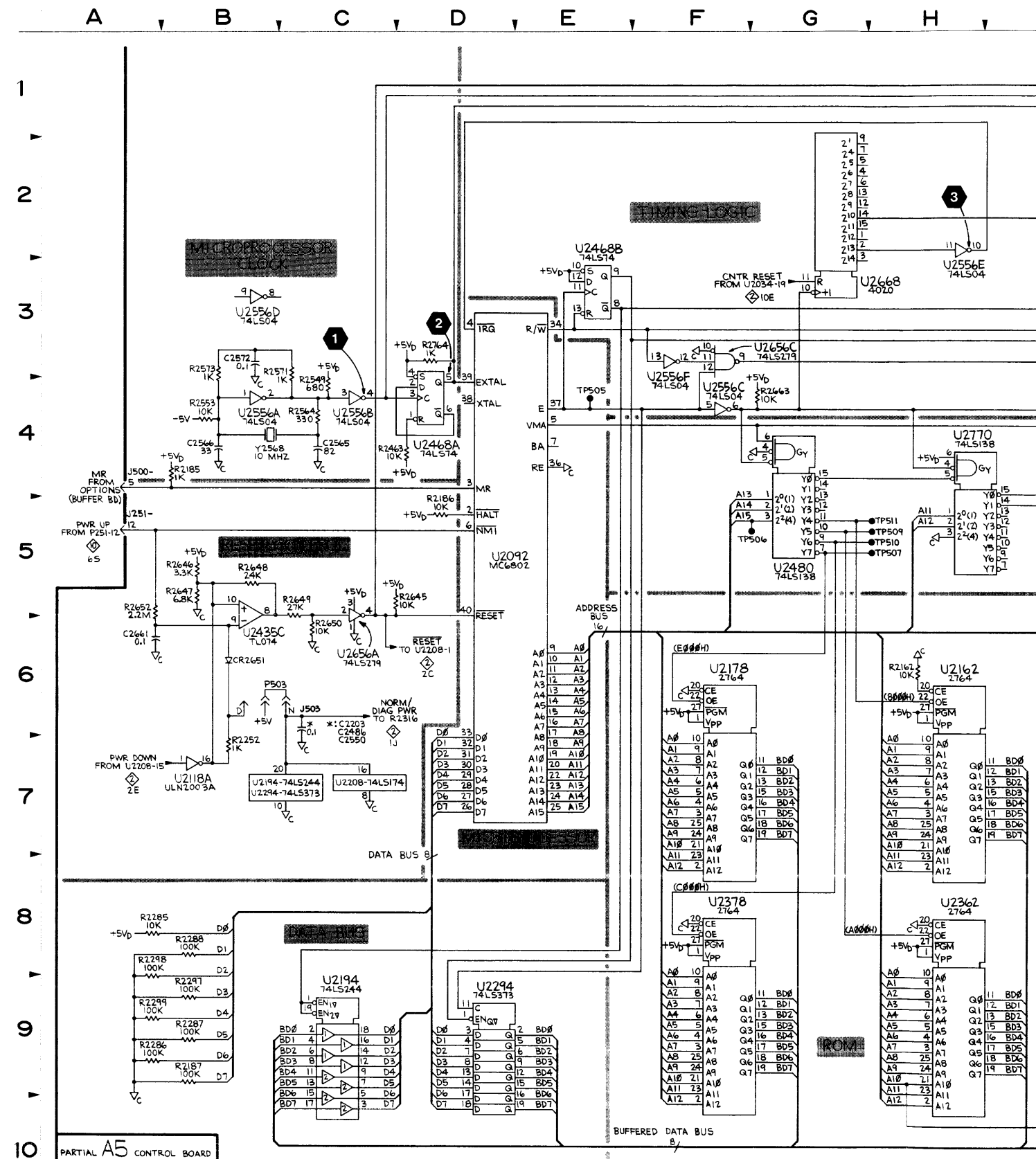

BOARD LOCATION
2H
2H
2E
3H
3J
2J
3E
4J
4J
4K
3K
3J
3J
3J
3J
4H
4H

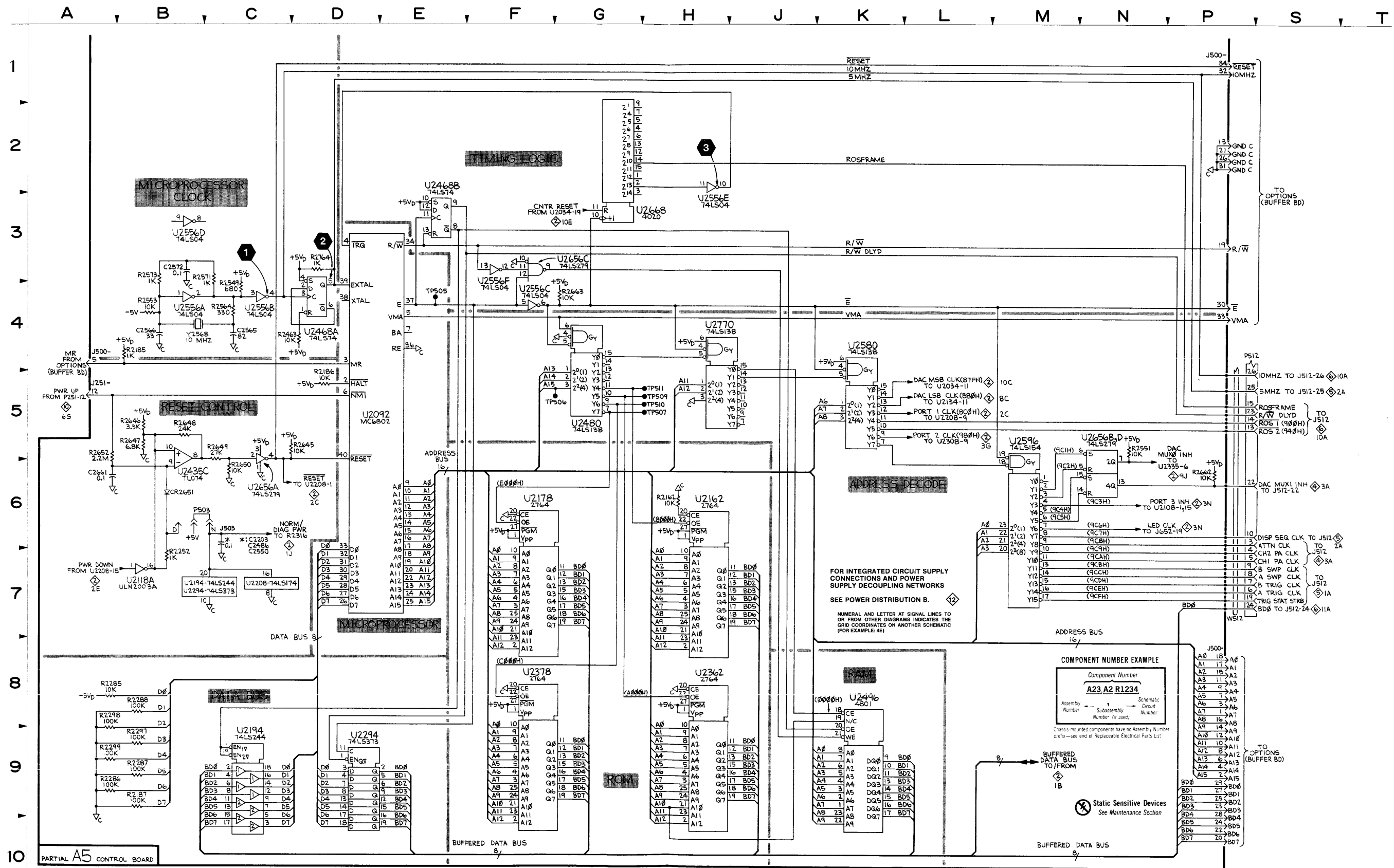

me
 1 (address 0900 hex)
 2 (address 0940 hex)

ed
 atus strobe

ex
 ex
 1 hex - 09CF hex

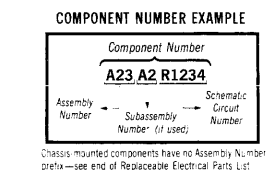

Static Sensitive Devices
 See Maintenance Section

ANALOG CONTROL DIAGRAM



ASSEMBLY A5											
CIRCUIT NUMBER	SCHEM LOCATION	BOARD LOCATION	CIRCUIT NUMBER	SCHEM LOCATION	BOARD LOCATION	CIRCUIT NUMBER	SCHEM LOCATION	BOARD LOCATION	CIRCUIT NUMBER	SCHEM LOCATION	BOARD LOCATION
C2222	8H	2C	R2016	2L	3G	R2444	5F	4B	R2732	9N	4E
C2224	8H	1C	R2017	2K	3F	R2445	5G	2A	R2734	9N	4F
C2318	4J	2D	R2018	3K	3F	R2446	5F	2A	R2735	9M	4E
C2326	5P	3D	R2019	2L	3G	R2447	6F	4C	R2741	9M	4F
C2327	8M	4E	R2020	3K	4G	R2448	6G	3B	R2742	10M	4F
C2329	8L	4E	R2022	2K	4G	R2449	6G	3A	R2745	10L	4F
C2330	6K	4D	R2023	2N	3G	R2450	6H	3B			
C2441	6L	3D	R2028	3L	3F	R2451	6H	3B	TP503	5P	3B
C2443	7N	4D	R2029	2N	3G	R2452	6H	3B	TP504	6P	4C
C2524	5N	3C	R2040	10C	2B	R2504	3E	4A			
C2530	6L	4C	R2103	4K	2E	R2505	2D	4B	U2008	2N	3G
C2536	8N	4F	R2113	2P	2E	R2506	3D	4A	U2008	3N	3G
C2540	9L	4E	R2123	2N	4F	R2507	3E	4A	U2034	9D	2B
C2542	9L	4E	R2127	8H	2C	R2508	3E	4B	U2108	2P	2G
C2638	9L	3E	R2140	8G	2B	R2509	3D	4B	U2118B	2K	3E
C2640	9K	4D	R2141	8D	2A	R2510	3E	4B	U2118C	3K	3E
			R2142	8D	1B	R2511	3D	4A	U2118D	2K	3E
CR2004	1K	4G	R2143	8G	1A	R2512	5E	4C	U2118E	2K	3E
CR2021	3K	4G	R2144	8E	2A	R2513	4D	4C	U2118F	3K	3E
CR2122	2P	3G	R2145	8E	2A	R2514	4D	4C	U2118G	2N	3E
CR2723	5P	3A	R2224	6G	4C	R2515	5D	4B	U2118	1L	3E
CR2731	9M	4E	R2227	8H	2C	R2516	5E	4C	U2134	8D	2D
CR2733	9N	4E	R2228	7H	2C	R2517	5E	4B	U2208	2D	2E
CR2742	9M	4E	R2229	7H	2C	R2518	5E	4B	U2214	5K	2D
CR2744	9L	4E	R2230	7G	2C	R2519	5D	4B	U2234	7J	2B
			R2241	8E	2B	R2520	5D	4B	U2308	3H	2F
J501	7H	3B	R2242	8E	1A	R2521	5D	4B	U2335	8K	3D
J502	2M	2G	R2243	8F	1A	R2522	5N	3C	U2408	4F	3A
J651	2B	3A	R2244	8F	1B	R2525	5N	4D	U2418	5F	3B
J651	5P	3A	R2245	8F	1C	R2532	7N	4E	U2427A	6M	3C
J651	8B	3A	R2246	8G	2A	R2534	7N	4E	U2427B	6L	3C
J652	3P	2A	R2303	4G	2F	R2535	8N	4E	U2427C	7N	3C
J652	5B	2A	R2312	2F	3D	R2539	8N	4E	U2427D	5N	3C
			R2313	4F	3D	R2540	7L	4D	U2435A	9M	3E
P501	7G	3B	R2314	2J	3C	R2541	7L	4D	U2435B	9L	3E
P511	4A	4C	R2315	2J	3C	R2542	9L	4E	U2435D	8N	3E
P511	6S	4C	R2316	2J	3C	R2543	9L	4E	U2456	5J	3B
P511	9A	4C	R2317	4J	3D	R2545	5G	2A	U2634A	7M	4D
P512	10S	4H	R2319	4J	2D	R2546	5H	2A	U2634B	8L	4D
P512	1A	4H	R2320	5J	2D	R2547	5H	2B			
P512	4S	4H	R2324	6K	3C	R2609	3D	4B	VR2003	1K	4F
			R2325	5J	3C	R2610	3D	4B	VR2526	6N	4A
Q2025	2N	3G	R2330	6L	4C	R2611	3D	4B			
Q2322	5P	3D	R2340	10N	2E	R2612	3E	4B	W511	10B	4C
			R2341	10P	3E	R2613	5D	4B	W511	5B	4C
R2012	2L	3F	R2342	10N	3D	R2614	5E	4B	W511	9P	4C
R2013	2K	3F	R2343	10P	3E	R2703	5P	4B	W512	10P	4H
R2014	3K	3F	R2344	10N	3E	R2730	8M	4D	W512	1B	4H
R2015	2L	3F	R2345	10P	3E	R2731	8L	4D	W512	5P	4H

Partial A5 also shown on diagrams 1 and 12.

ACRONYM DICTIONARY

The following listing explains some of the less obvious acronyms and signal labels used on this schematic. Acronyms and labels not shown in this listing may be included in the circuit descriptions (Section 3) and should be obvious if a little thought is given to the intended circuit function.

- A TIM REF ... A timing reference
- ATTN STRB ... attenuator strobe
- BD0 - BD7 ... buffered data bits 0 - 7
- B TIM REF ... B timing reference
- CH1 OVL ... channel 1 overload
- CH2 OVL ... channel 2 overload
- CH1 PRB ... channel 1 probe
- CH2 PRB ... channel 2 probe
- CH3 PRB ... channel 3 probe
- CH4 PRB ... channel 4 probe

- CONT DATA ... control data
- DAC MUX0 INH ... DAC multiplexer 0 inhibit
- DAC MUX1 A0 ... DAC multiplexer 1, address bit 0
- DAC MUX1 A1 ... DAC multiplexer 1, address bit 1
- DAC MUX1 A2 ... DAC multiplexer 1, address bit 2
- DAC MUX1 IN ... DAC multiplexer input
- GND C ... virtual ground "C"
- OEA35 ... option EAROM +35 volt
- OEACLK ... option EAROM clock
- OEAI/O ... option EAROM input/output
- OEAC1 ... option EAROM mode code, bit 1
- OEAC2 ... option EAROM mode code, bit 2
- OEAC3 ... option EAROM mode code, bit 3
- PORT 3 INH (9C3H) ... port 3 inhibit
- RO DO ... readout data out
- RO ON ... readout on
- SI ... scope identification
- TSO ... trigger status output

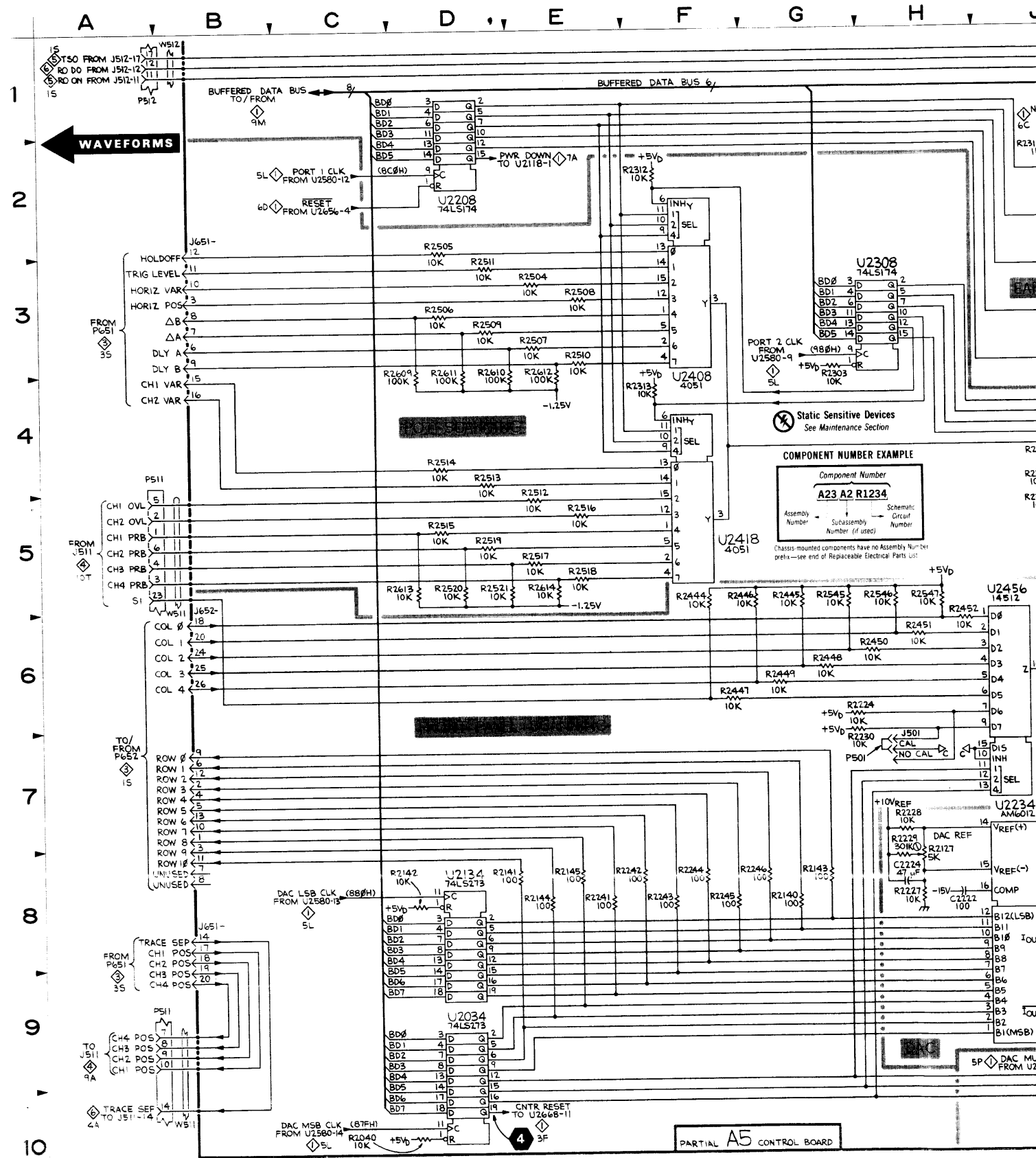

2445

PARTIAL A5 CONTROL BOARD

IT ER	SCHEM LOCATION	BOARD LOCATION
	9N	4E
	9N	4F
	9M	4E
	9M	4F
	10M	4F
	10L	4F
	5P	3B
	6P	4C
	2N	3G
	3N	3G
	9D	2B
	2P	2G
	2K	3E
	3K	3E
	2K	3E
	2K	3E
	3K	3E
	2N	3E
	1L	3E
	8D	1B
	2D	2E
	5K	2D
	7J	2B
	3H	2F
	8K	3D
	4F	3A
	5F	3B
	6M	3C
	6L	3C
	7N	3C
	5N	3C
	9M	3E
	9L	3E
	8N	3E
	5J	3B
	7M	4D
	8L	4D
	1K	4F
	6N	4A
	10B	4C
	5B	4C
	9P	4C
	10P	4H
	1B	4H
	5P	4H

lexer 0 inhibit
 exer 1, address bit 0
 exer 1, address bit 1
 exer 1, address bit 2
 exer input
 volt
 ck
 it/output
 e code, bit 1
 e code, bit 2
 e code, bit 3
 inhibit

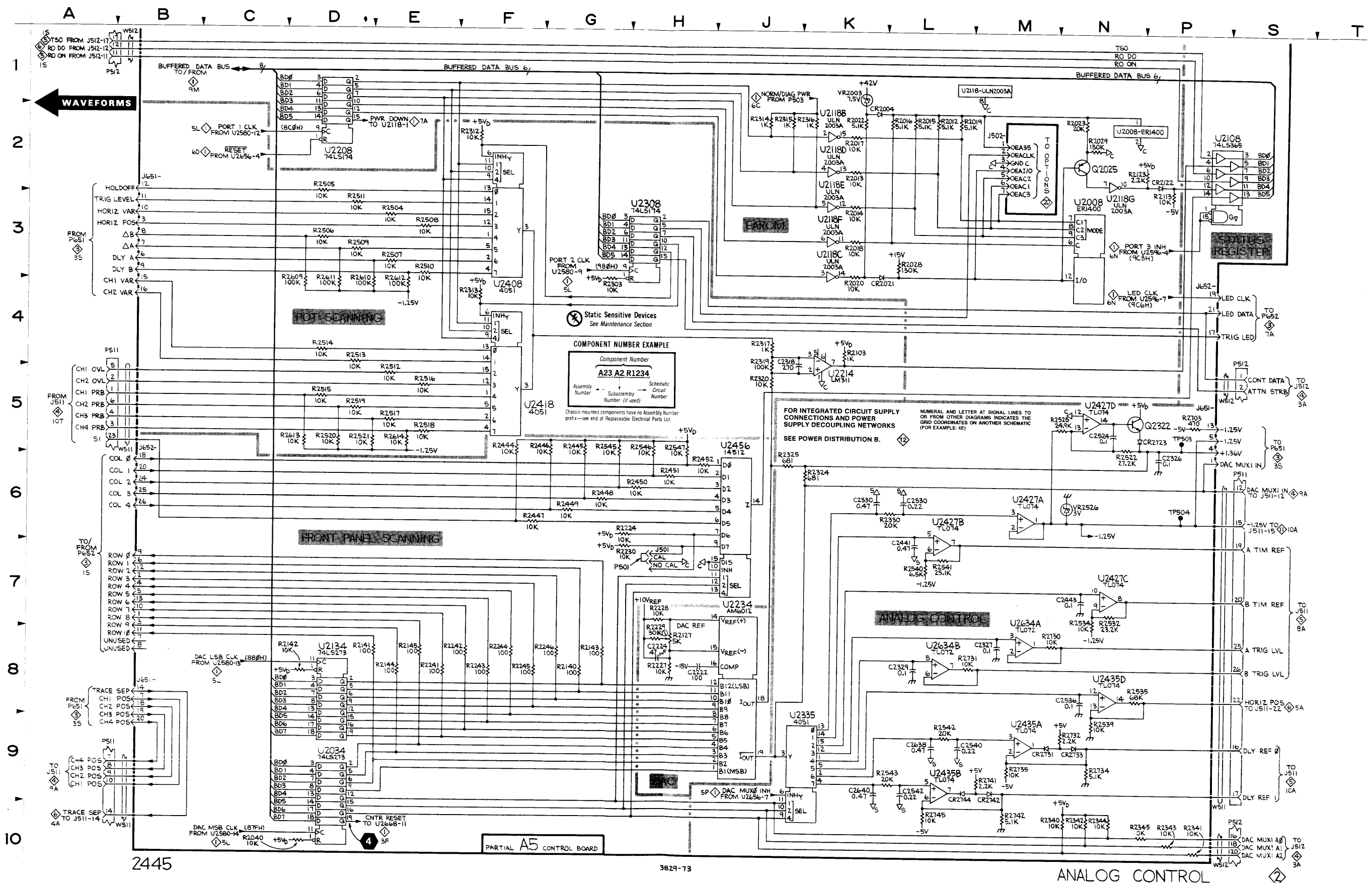

2445

3829-73

ANALOG CONTROL

PARTIAL A5 CONTROL BOARD

Static Sensitive Devices
 See Maintenance Section

Component Number Example
 A23 A2 R1234
 Assembly Number Subassembly Number (if used) Schematic Circuit Number

Chassis-mounted components have no Assembly Number prefix—see end of Replaceable Electrical Parts List

FOR INTEGRATED CIRCUIT SUPPLY CONNECTIONS AND POWER SUPPLY DECOUPLING NETWORKS
 SEE POWER DISTRIBUTION B.

NUMERAL AND LETTER AT SIGNAL LINES TO OR FROM OTHER DIAGRAMS INDICATES THE GRID COORDINATES ON ANOTHER SCHEMATIC (FOR EXAMPLE: 4E)

WAVEFORMS

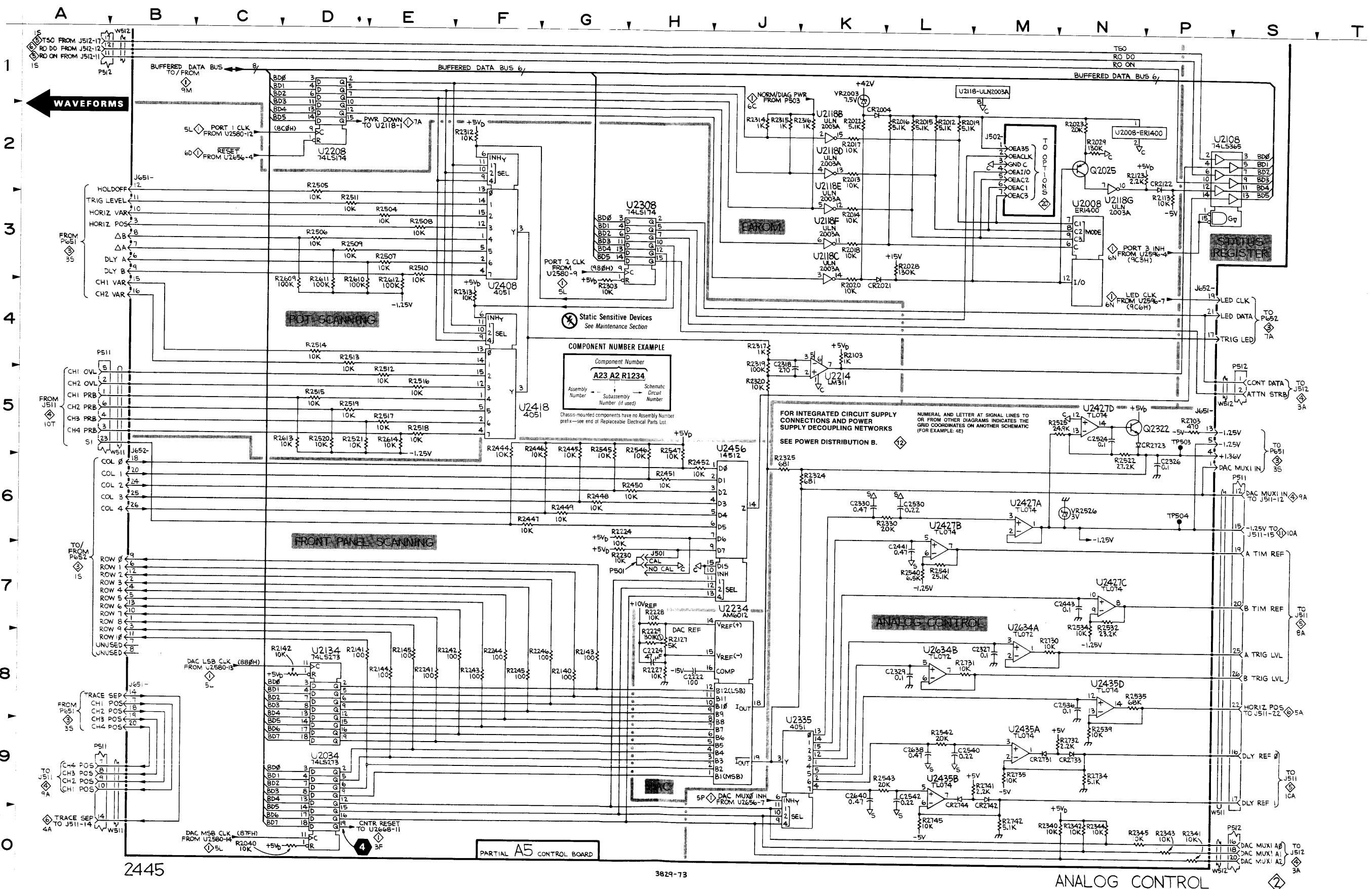

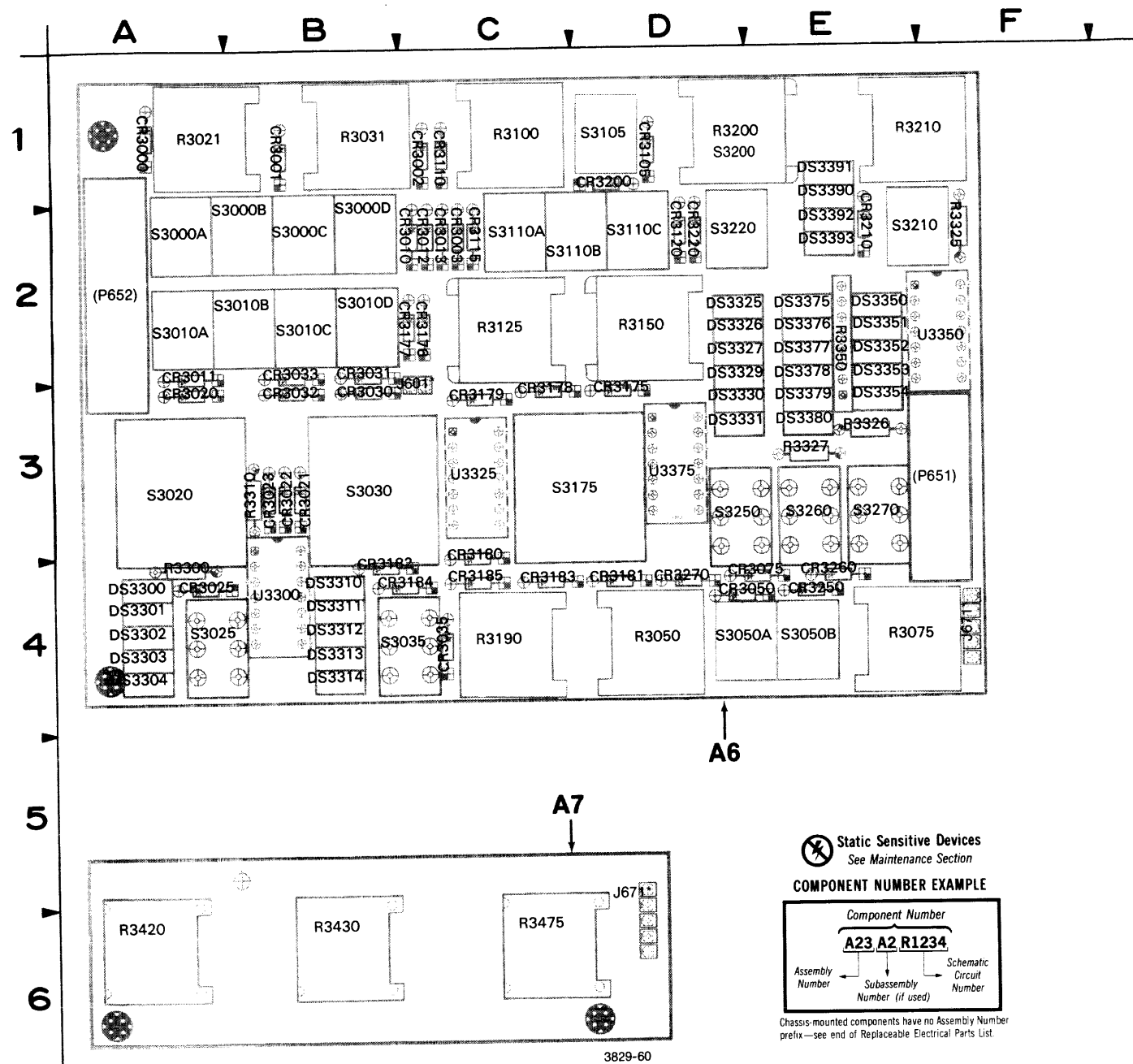

Figure 9-6. A6—Front Panel and A7—Front Panel Variable boards.

* LABELED ON SOME BOARDS AS "P" VICE "J".

() COMPONENTS WITHIN PARENTHESES MAY NOT BE LOCATED PRECISELY AS SHOWN BUT ARE NEAR THEIR INDICATED POSITION.

ALL COMPONENTS MOUNTED ON A7—FRONT PANEL VARIABLE CIRCUIT BOARD ARE SHOWN ON SCHEMATIC

DIAGRAM 3

A6—FRONT PANEL BOARD

CIRCUIT NUMBER	SCHEM NUMBER	CIRCUIT NUMBER	SCHEM NUMBER	CIRCUIT NUMBER	SCHEM NUMBER	CIRCUIT NUMBER	SCHEM NUMBER
CR3000	3	CR3200	3	DS3392	3	S3010	3
CR3001	3	CR3210	3	DS3393	3	S3010	3
CR3002	3	CR3220	3	J601	3	S3010	3
CR3003	3	CR3250	3	J671	3	S3010	3
CR3010	3	CR3260	3	P651	3	S3020	3
CR3011	3	CR3270	3	P651	12	S3025	3
CR3012	3	DS3300	3	P652	3	S3030	3
CR3013	3	DS3301	3	P652	3	S3035	3
CR3020	3	DS3302	3	P652	12	S3050	3
CR3021	3	DS3303	3	R3021	3	S3050	3
CR3022	3	DS3304	3	R3031	3	S3105	3
CR3023	3	DS3310	3	R3050	3	S3110	3
CR3025	3	DS3311	3	R3075	3	S3110	3
CR3030	3	DS3312	3	R3100	3	S3110	3
CR3031	3	DS3313	3	R3125	3	S3175	3
CR3032	3	DS3314	3	R3150	3	S3175	3
CR3033	3	DS3325	3	R3190	3	S3200	3
CR3035	3	DS3326	3	R3200	3	S3210	3
CR3050	3	DS3327	3	R3210	3	S3220	3
CR3075	3	DS3329	3	R3300	3	S3250	3
CR3105	3	DS3330	3	R3310	3	S3260	3
CR3110	3	DS3331	3	R3325	3	S3270	3
CR3115	3	DS3350	3	R3326	3	U3300	3
CR3120	3	DS3351	3	R3327	3	U3300	12
CR3175	3	DS3352	3	R3350	3	U3325	3
CR3176	3	DS3353	3	R3350	3	U3325	12
CR3177	3	DS3354	3	R3350	3	U3350	3
CR3178	3	DS3375	3	R3350	3	U3350	12
CR3179	3	DS3376	3	R3350	3	U3375	3
CR3180	3	DS3377	3	R3350	3	U3375	12
CR3181	3	DS3378	3	R3350	3	W651	3
CR3182	3	DS3379	3	S3000	3	W651	12
CR3183	3	DS3380	3	S3000	3	W652	3
CR3184	3	DS3390	3	S3000	3	W652	3
CR3185	3	DS3391	3	S3000	3	W652	12

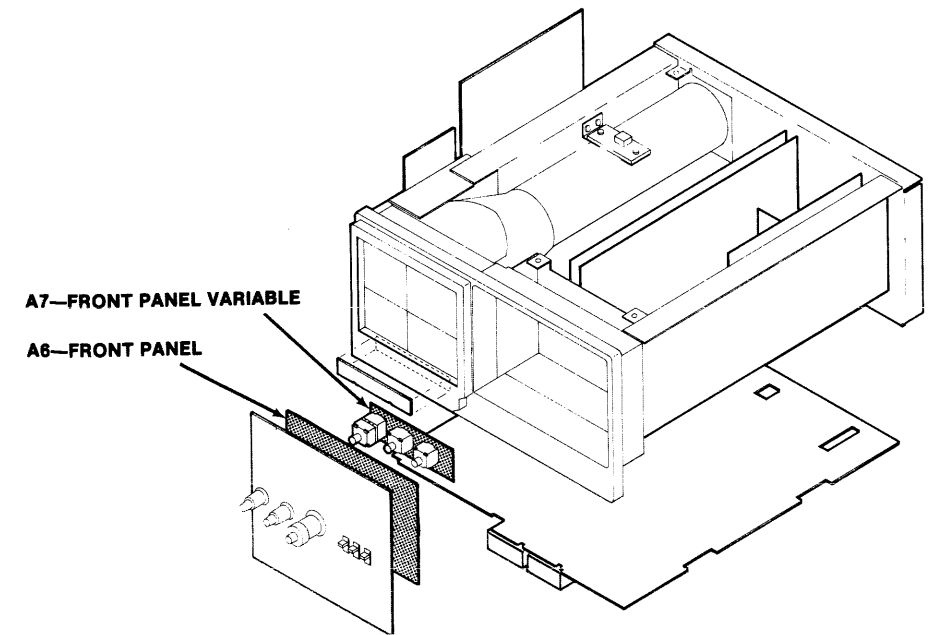
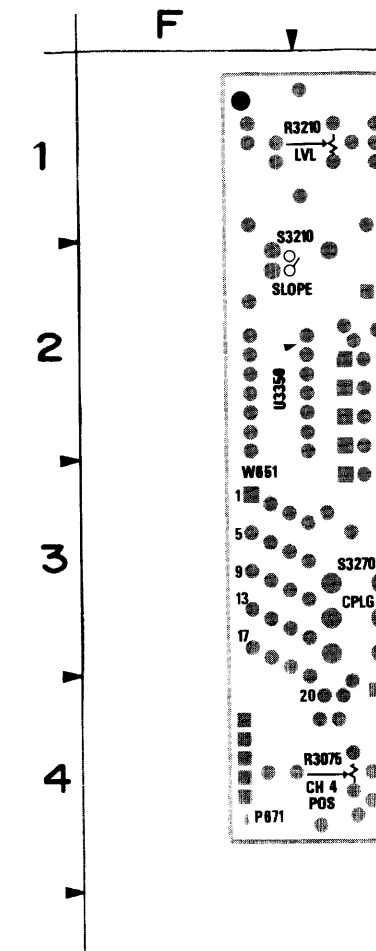

F

A6—FRONT PANEL BOARD

CIRCUIT NUMBER	SCHEM NUMBER	CIRCUIT NUMBER	SCHEM NUMBER	CIRCUIT NUMBER	SCHEM NUMBER	CIRCUIT NUMBER	SCHEM NUMBER
CR3000	3	CR3200	3	DS3392	3	S3010	3
CR3001	3	CR3210	3	DS3393	3	S3010	3
CR3002	3	CR3220	3	J601	3	S3010	3
CR3003	3	CR3250	3	J671	3	S3010	3
CR3010	3	CR3260	3	P651	3	S3020	3
CR3011	3	CR3270	3	P651	12	S3025	3
CR3012	3	DS3300	3	P652	3	S3030	3
CR3013	3	DS3301	3	P652	3	S3035	3
CR3020	3	DS3302	3	P652	12	S3050	3
CR3021	3	DS3303	3	R3021	3	S3050	3
CR3022	3	DS3304	3	R3031	3	S3105	3
CR3023	3	DS3310	3	R3050	3	S3110	3
CR3025	3	DS3311	3	R3075	3	S3110	3
CR3030	3	DS3312	3	R3100	3	S3110	3
CR3031	3	DS3313	3	R3125	3	S3175	3
CR3032	3	DS3314	3	R3150	3	S3175	3
CR3033	3	DS3325	3	R3190	3	S3175	3
CR3035	3	DS3326	3	R3200	3	S3200	3
CR3050	3	DS3327	3	R3210	3	S3220	3
CR3075	3	DS3329	3	R3300	3	S3250	3
CR3105	3	DS3330	3	R3310	3	S3260	3
CR3110	3	DS3331	3	R3325	3	S3270	3
CR3115	3	DS3350	3	R3326	3	U3300	3
CR3120	3	DS3351	3	R3327	3	U3300	12
CR3175	3	DS3352	3	R3350	3	U3325	3
CR3176	3	DS3353	3	R3350	3	U3325	12
CR3177	3	DS3354	3	R3350	3	U3350	3
CR3178	3	DS3375	3	R3350	3	U3350	12
CR3179	3	DS3376	3	R3350	3	U3375	3
CR3180	3	DS3377	3	R3350	3	U3375	12
CR3181	3	DS3378	3	R3350	3	W651	3
CR3182	3	DS3379	3	S3000	3	W651	12
CR3183	3	DS3380	3	S3000	3	W652	3
CR3184	3	DS3390	3	S3000	3	W652	3
CR3185	3	DS3391	3	S3000	3	W652	12

F

E

D

C

B

A

1

2

3

4

3829-61

Figure 9-7. Circuit view of A6—Front Panel.

A7—FRONT PANEL VARIABLE

A6—FRONT PANEL

 Static Sensitive Devices
See Maintenance Section

COMPONENT NUMBER EXAMPLE

Component Number		
A23 A2 R1234		
Assembly Number	Subassembly Number (if used)	Schematic Circuit Number

Chassis-mounted components have no Assembly Number prefix—see end of Replaceable Electrical Parts List.

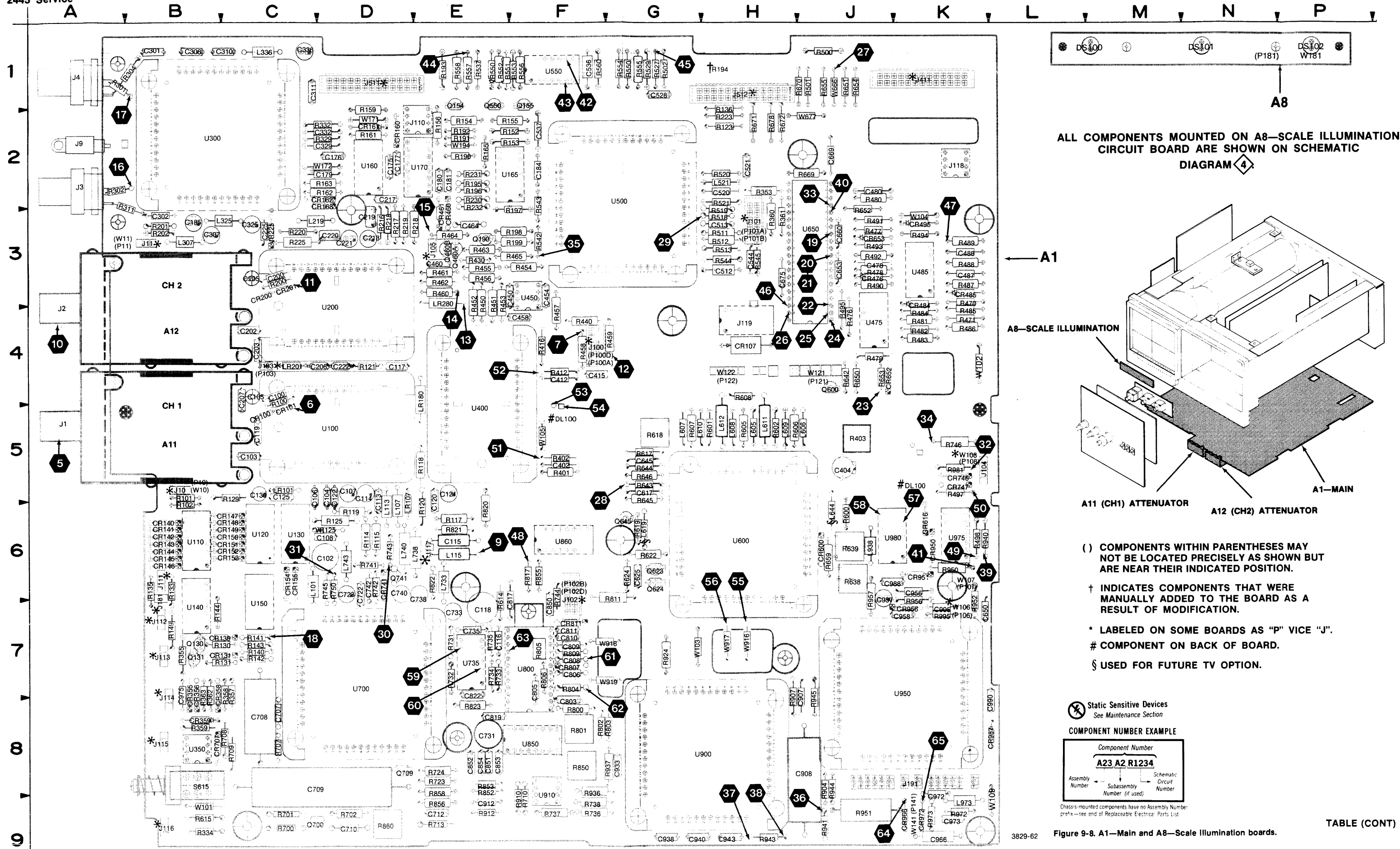

ALL COMPONENTS MOUNTED ON A8—SCALE ILLUMINATION CIRCUIT BOARD ARE SHOWN ON SCHEMATIC DIAGRAM 4.

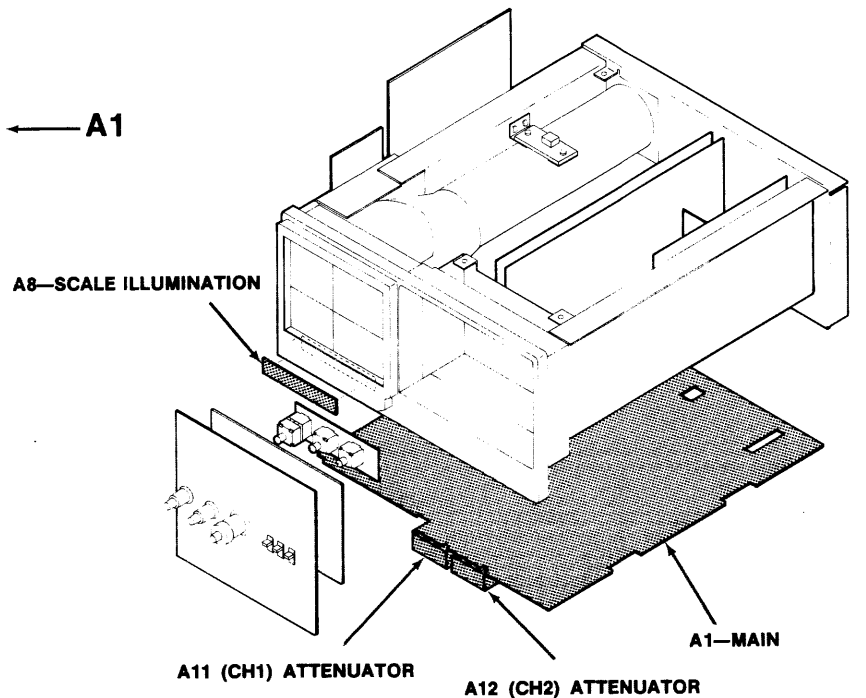

- () COMPONENTS WITHIN PARENTHESES MAY NOT BE LOCATED PRECISELY AS SHOWN BUT ARE NEAR THEIR INDICATED POSITION.
- † INDICATES COMPONENTS THAT WERE MANUALLY ADDED TO THE BOARD AS A RESULT OF MODIFICATION.
- * LABELED ON SOME BOARDS AS "P" VICE "J".
- # COMPONENT ON BACK OF BOARD.
- § USED FOR FUTURE TV OPTION.

Static Sensitive Devices
See Maintenance Section

COMPONENT NUMBER EXAMPLE

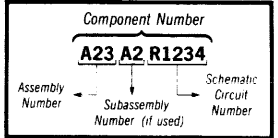

Chassis-mounted components have no Assembly Number; prefix—see end of Replaceable Electrical Parts List

Figure 9-8. A1—Main and A8—Scale Illumination boards.

F G H J K L M N P

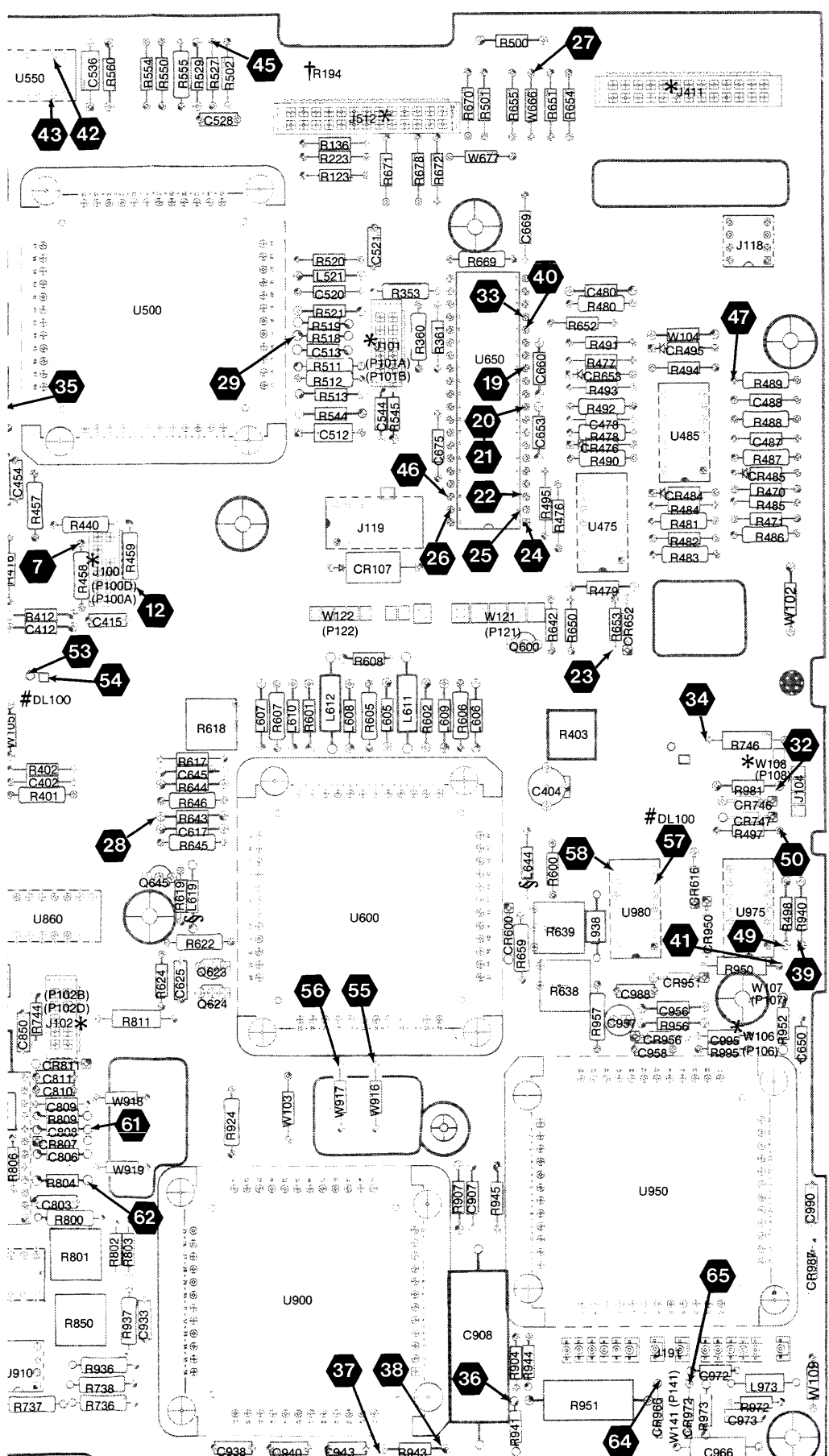

ALL COMPONENTS MOUNTED ON A8—SCALE ILLUMINATION CIRCUIT BOARD ARE SHOWN ON SCHEMATIC DIAGRAM 4.

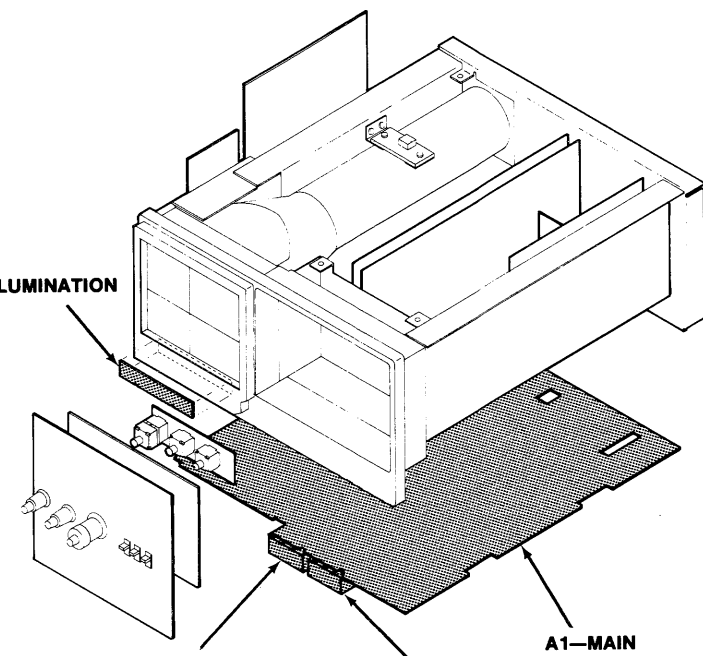

- () COMPONENTS WITHIN PARENTHESES MAY NOT BE LOCATED PRECISELY AS SHOWN BUT ARE NEAR THEIR INDICATED POSITION.
- † INDICATES COMPONENTS THAT WERE MANUALLY ADDED TO THE BOARD AS A RESULT OF MODIFICATION.
- * LABELED ON SOME BOARDS AS "P" VICE "J".
- # COMPONENT ON BACK OF BOARD.
- § USED FOR FUTURE TV OPTION.

⊗ Static Sensitive Devices
See Maintenance Section

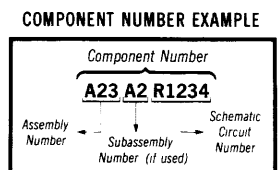

Chassis mounted components have no Assembly Number prefix—see end of Replaceable Electrical Parts List.

A1—MAIN BOARD

CIRCUIT NUMBER	SCHEM NUMBER	CIRCUIT NUMBER	SCHEM NUMBER	CIRCUIT NUMBER	SCHEM NUMBER	CIRCUIT NUMBER	SCHEM NUMBER	CIRCUIT NUMBER	SCHEM NUMBER
C100	4	C723	11	CR950	5	P101	5	R301	4
C102	11	C731	11	CR951	5	P101	5	R302	4
C103	4	C733	11	CR956	6	P102	5	R304	4
C104	4	C735	6	CR966	6	P102	5	R311	4
C105	4	C738	11	CR972	6	P103	4	R329	4
C106	11	C740	11	CR987	11	P106	6	R332	4
C107	11	C742	5	DL100	6	P107	5	R334	5
C108	11	C803	6	J9	5	P108	5	R353	5
C113	11	C805	6	J10	4	P121	11	R355	5
C114	11	C806	6	J11	4	P121	11	R357	5
C115	4	C808	6	J100	4	P122	5	R358	5
C116	4	C809	6	J100	4	P122	11	R359	5
C117	4	C810	11	J100	4	P141	6	R360	5
C118	4	C811	11	J101	5	P141	6	R361	5
C119	11	C817	6	J101	5	Q130	4	R362	5
C120	11	C819	11	J102	5	Q131	4	R363	5
C121	11	C822	6	J102	5	Q154	5	R401	6
C122	4	C850	11	J102	5	Q155	5	R402	6
C125	11	C851	5	J103	4	Q190	4	R403	6
C130	4	C852	5	J104	5	Q460	4	R412	6
C175	4	C853	5	J104	5	Q460	4	R416	6
C176	4	C854	5	J105	4	Q550	5	R430	4
C177	4	C907	5	J110	4	Q600	6	R440	4
C179	4	C908	5	J111	4	Q623	6	R450	4
C180	5	C912	5	J112	8	Q624	6	R451	4
C181	5	C933	11	J113	5	Q645	5	R452	4
C184	4	C938	11	J114	8	Q700	11	R453	4
C185	4	C940	11	J115	8	Q709	5	R454	4
C200	4	C943	11	J116	5	Q741	5	R455	4
C202	4	C956	6	J117	4	R100	4	R456	4
C203	4	C957	6	J118	5	R101	4	R457	4
C205	4	C958	11	J119	11	R102	4	R458	4
C206	4	C966	11	J181	4	R114	4	R459	4
C207	11	C972	6	J191	6	R115	4	R460	4
C217	4	C973	11	J191	11	R117	4	R461	4
C218	11	C975	8	J191	11	R118	4	R462	4
C219	11	C988	11	J411	5	R119	4	R463	4
C220	11	C990	11	J411	5	R120	11	R464	4
C221	11	C995	6	J411	6	R121	4	R465	4
C222	4	CR100	4	J411	6	R123	4	R470	6
C225	11	CR101	4	J411	11	R125	11	R471	6
C301	4	CR107	11	J511	4	R129	4	R476	6
C302	4	CR130	4	J511	4	R130	4	R477	6
C306	5	CR131	4	J511	5	R131	4	R478	6
C307	11	CR140	4	J511	6	R133	4	R479	6
C310	4	CR141	4	J511	11	R135	4	R480	6
C311	4	CR142	4	J511	11	R136	4	R481	6
C325	11	CR143	4	J512	4	R140	4	R482	6
C329	4	CR144	4	J512	5	R141	4	R483	6
C332	4	CR145	4	J512	5	R142	4	R484	6
C336	11	CR146	4	J512	6	R143	4	R485	6
C402	6	CR147	4	J512	6	R144	4	R486	6
C404	6	CR148	4	J512	11	R149	4	R487	6
C412	6	CR149	4	L101	11	R152	5	R488	6
C415	11	CR150	4	L107	11	R153	5	R489	6
C450	4	CR151	4	L113	11	R154	5	R490	6
C454	4	CR152	4	L115	4	R155	5	R491	6
C458	11	CR153	4	L219	11	R156	5	R492	6
C460	4	CR154	4	L307	11	R159	4	R493	6
C464	4	CR155	4	L325	11	R161	4	R494	6
C478	6	CR160	4	L336	11	R162	4	R495	6
C480	11	CR161	4	L521	11	R163	4	R497	6
C487	6	CR162	4	L605	6	R165	5	R498	6
C488	6	CR163	4	L606	6	R190	4	R500	6
C512	5	CR200	4	L607	6	R191	4	R501	6
C513	5	CR201	4	L608	6	R192	4	R502	4
C520	5	CR355	5	L609	6	R193	4	R511	5
C521	11	CR356	5	L610	6	R194	4	R512	5
C528	5	CR358	5	L611	6	R195	4	R513	5
C536	5	CR359	5	L612	6	R196	4	R518	5
C537	5	CR460	4	L619	6	R197	4	R519	5
C544	5	CR461	4	L644	6	R198	4	R520	5
C617	6	CR476	6	L733	11	R199	4	R521	5
C625	6	CR484	6	L738	11	R200	4	R527	5
C645	5	CR485	6	L740	11	R201	4	R529	5
C650	5	CR495	6	L743	11	R202	4	R537	5
C653	5	CR600	6	L938	11	R216	4	R542	5
C660	5	CR616	6	L973	11	R217	4	R543	5
C669	5	CR652	5	LR101	11	R218	4	R544	5
C675	11	CR653	5	LR107	11	R219	4	R545	5
C707	5	CR707	5	LR180	4	R220	11	R550	5
C708	5	CR741	5	LR201	11	R223	4	R551	5
C709	5	CR746	5	LR218	11	R225	11	R552	5
C710	11	CR747	5	LR280	4	R230	4	R553	5
C712	5	CR807	11	P100	4	R231	4	R554	5
C722	11	CR811	11	P100	4	R232	4	R555	5

TABLE (CONT)

3829-62 Figure 9-8. A1—Main and A8—Scale Illumination boards.

FRONT PANEL CONTROLS DIAGRAM

3

ASSEMBLY A6											
CIRCUIT NUMBER	SCHEM LOCATION	BOARD LOCATION	CIRCUIT NUMBER	SCHEM LOCATION	BOARD LOCATION	CIRCUIT NUMBER	SCHEM LOCATION	BOARD LOCATION	CIRCUIT NUMBER	SCHEM LOCATION	BOARD LOCATION
CR03000	2J	1A	CR3200	3J	1D	DS3391	10P	1E	S3000B	3K	2B
CR3001	2K	1B	CR3210	4N	2E	DS3392	8L	2E	S3000C	3M	2B
CR3002	2M	1C	CR3220	5L	2D	DS3393	7F	2E	S3000D	3N	2B
CR3003	2N	2C	CR3250	5K	4E				S3010A	3L	2A
CR3010	2L	2C	CR3260	6J	4E	J601	5D	3C	S3010B	3D	2B
CR3011	3D	2A	CR3270	2B	4D	J671	7P	4F	S3010C	3K	2B
CR3012	3K	2C							S3010D	3L	2B
CR3013	3L	2C	DS3300	6B	4A	P651	3S	3F	S3020	3D	3A
CR3020	3B	3A	DS3301	6C	4A	P652	1S	2A	S3025	1B	4A
CR3021	3B	3B	DS3302	6C	4A	P652	7A	2A	S3030	4D	3B
CR3022	3B	3B	DS3303	7C	4A				S3035	2C	4B
CR3023	3C	3B	DS3304	7D	4A	R3021	3P	1A	S3050A	2B	4D
CR3025	2C	4A	DS3310	7D	4B	R3031	4P	1B	S3050B	2A	4E
CR3030	5B	3B	DS3311	7E	4B	R3050	4P	4D	S3105	4J	1D
CR3031	5B	2B	DS3312	7E	4B	R3075	5P	4E	S3110A	4M	2C
CR3032	5B	3B	DS3313	7E	4B	R3100	5P	1C	S3110B	4L	2C
CR3033	5C	2B	DS3314	7F	4B	R3125	5P	2C	S3110C	4K	2D
CR3035	2C	4C	DS3325	8H	2D	R3150	6P	2D	S3175A	3H	3C
CR3050	2C	4D	DS3326	8H	2D	R3190	3P	4C	S3175B	5H	3C
CR3075	2B	4D	DS3327	8G	2D	R3200	6P	1D	S3200	3J	1D
CR3105	4J	1D	DS3329	7G	2D	R3210	6P	1E	S3210	4N	2E
CR3110	4M	1C	DS3330	8J	3D	R3300	6D	4A	S3220	5L	2D
CR3115	4L	2C	DS3331	8J	3D	R3310	7F	3B	S3250	5K	3D
CR3120	4K	2D	DS3350	8J	2E	R3325	8L	2F	S3260	5J	3E
CR3175	2F	3D	DS3351	8K	2E	R3326	9N	3E	S3270	1A	3E
CR3176	2F	2C	DS3352	8K	2E	R3327	9P	3E			
CR3177	2F	2C	DS3353	8L	2E	R3350A	9N	2E	U3300	8B	4B
CR3178	2G	3C	DS3354	8L	3E	R3350B	9M	2E	U3325	9E	3C
CR3179	2G	3C	DS3375	9M	2E	R3350C	8M	2E	U3350	9H	2F
CR3180	5F	3C	DS3376	9M	2E	R3350D	7J	2E	U3375	10L	3D
CR3181	6F	4D	DS3377	9N	2E	R3350E	10P	2E			
CR3182	6F	4B	DS3378	9N	2E	R3350F	7G	2E	W651	8S	3F
CR3183	6G	4C	DS3379	9N	3E	R3350G	7M	2E	W652	10A	2A
CR3184	6G	4B	DS3380	9P	3E				W652	3S	2A
CR3185	5C	4C	DS3390	7G	1E	S3000A	3J	2A			

Partial A6 also shown on diagram 12.

ASSEMBLY A7											
CIRCUIT NUMBER	SCHEM LOCATION	BOARD LOCATION	CIRCUIT NUMBER	SCHEM LOCATION	BOARD LOCATION	CIRCUIT NUMBER	SCHEM LOCATION	BOARD LOCATION	CIRCUIT NUMBER	SCHEM LOCATION	BOARD LOCATION
J671	7N	5D	R3420	7M	6A	R3475	8M	6C			

CHASSIS MOUNTED PARTS											
CIRCUIT NUMBER	SCHEM LOCATION	BOARD LOCATION	CIRCUIT NUMBER	SCHEM LOCATION	BOARD LOCATION	CIRCUIT NUMBER	SCHEM LOCATION	BOARD LOCATION	CIRCUIT NUMBER	SCHEM LOCATION	BOARD LOCATION
P601	5D	CHASSIS	S3185	5D	CHASSIS	W671	8N	CHASSIS			
P671	7N	CHASSIS									

ACRONYM DICTIONARY

The following listing explains some of the less obvious acronyms and signal labels used on this schematic. Acronyms and labels not shown in this listing may be included in the circuit descriptions (Section 3) and should be obvious if a little thought is given to the intended circuit function.

- CH1 VAR . . . channel 1 variable
- CH2 VAR . . . channel 2 variable
- DAC MUX1 IN . . . DAC multiplexer 1 input
- HORIZ VAR . . . horizontal variable

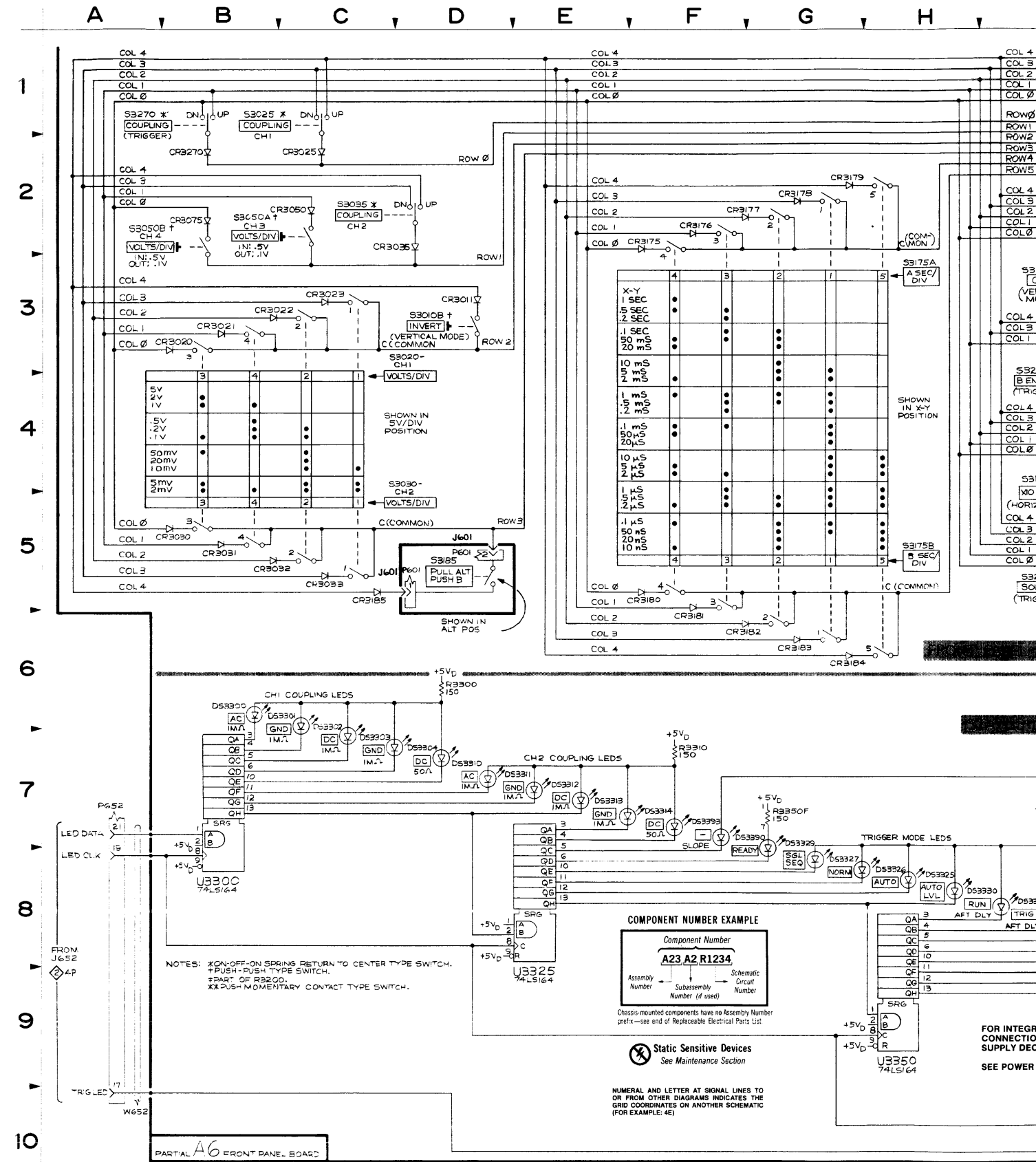

2445

3829-14

SCHEM LOCATION	BOARD LOCATION
3K	2B
3M	2B
3N	2B
3L	2A
3D	2B
3K	2B
3L	2B
3D	3A
1B	4A
4D	3B
2C	4B
2B	4D
2A	4E
4J	1D
4M	2C
4L	2C
4K	2D
5H	3C
3J	3C
4N	2E
5L	2D
5K	3D
5J	3E
1A	3E
8B	4B
9E	3C
9H	2F
10L	3D
8S	3F
10A	2A
3S	2A

SCHEM LOCATION	BOARD LOCATION

SCHEM LOCATION	BOARD LOCATION

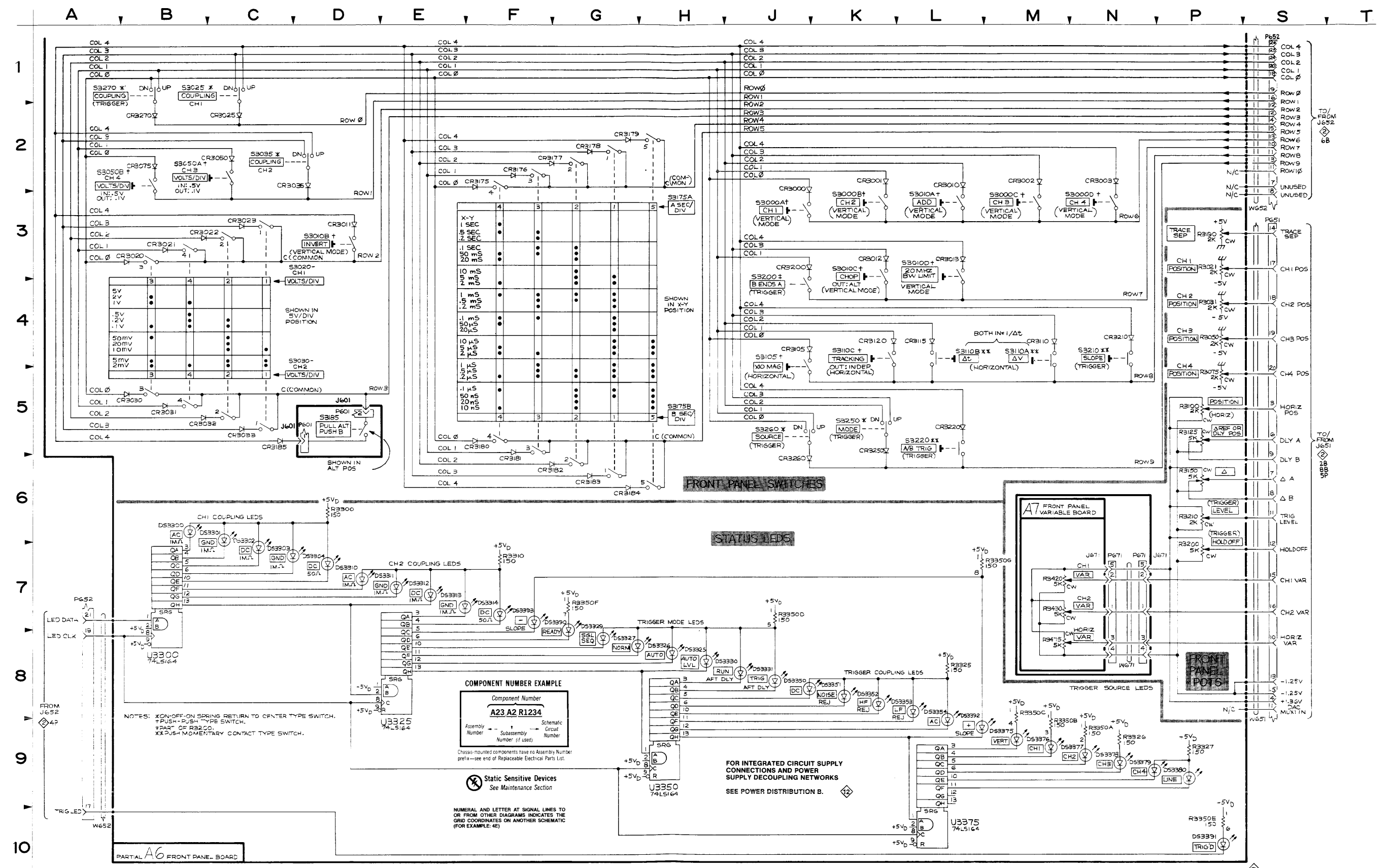

A1—MAIN BOARD (CONT)

CIRCUIT NUMBER	SCHEM NUMBER	CIRCUIT NUMBER	SCHEM NUMBER	CIRCUIT NUMBER	SCHEM NUMBER
R556	5	R907	5	U700	5
R557	5	R910	5	U700	11
R558	5	R912	5	U735	6
R560	5	R924	5	U735	6
R600	6	R936	5	U735	6
R601	6	R937	5	U735	6
R602	6	R940	5	U735	6
R605	6	R941	5	U800	6
R606	6	R943	5	U800	11
R607	6	R944	5	U850	5
R608	6	R945	5	U850	5
R614	6	R950	5	U850	6
R615	6	R951	11	U850	11
R617	6	R952	5	U860	5
R618	6	R956	6	U860	5
R619	6	R957	6	U860	6
R622	6	R972	6	U860	11
R624	6	R973	6	U900	5
R638	6	R981	5	U900	11
R639	6	R995	6	U910	5
R642	6	S615	6	U910	5
R643	5	U100	4	U910	11
R644	5	U100	11	U950	6
R645	5	U110	4	U950	11
R646	5	U110	11	U975	5
R650	6	U120	4	U975	5
R651	5	U120	11	U975	6
R652	5	U130	4	U975	6
R653	5	U130	4	U975	11
R654	5	U130	4	U980	5
R655	5	U130	4	U980	5
R659	6	U130	4	U980	6
R669	5	U130	4	U980	6
R670	5	U130	4	U980	11
R671	5	U130	11	VR125	11
R672	5	U140	4	VR225	11
R678	5	U140	11	VR550	5
R700	11	U150	4	W101	11
R701	11	U150	11	W102	11
R702	11	U160	4	W103	11
R707	5	U160	4	W104	11
R708	5	U160	4	W105	11
R709	5	U160	4	W106	6
R710	5	U160	11	W107	5
R713	5	U165	4	W108	5
R723	5	U165	5	W109	11
R724	5	U165	5	W121	11
R731	6	U165	5	W121	11
R732	6	U165	11	W122	5
R733	6	U170	4	W122	11
R734	6	U170	11	W141	6
R735	6	U200	4	W141	6
R736	5	U200	11	W171	4
R737	5	U300	4	W172	4
R738	5	U300	11	W194	4
R741	5	U350	5	W666	5
R742	5	U350	5	W677	5
R743	5	U350	11	W916	6
R744	5	U400	6	W917	6
R745	5	U400	11	W918	6
R746	5	U450	4	W919	6
R750	5	U450	4		
R800	6	U450	11		
R801	6	U475	6		
R802	6	U475	6		
R803	6	U475	6		
R804	6	U475	6		
R805	6	U475	6		
R806	6	U485	6		
R809	6	U485	6		
R811	11	U485	6		
R817	6	U485	6		
R820	6	U485	6		
R821	6	U500	5		
R822	6	U500	11		
R823	6	U550	5		
R850	6	U550	5		
R852	5	U550	5		
R853	5	U550	5		
R855	6	U550	5		
R856	6	U600	6		
R858	6	U600	11		
R860	6	U650	5		
R904	5	U650	11		

ACRONYM DICTIONARY

The following listing explains some of the less obvious acronyms and signal labels used on this schematic. Acronyms and labels not shown in this listing may be included in the circuit descriptions (Section 3) and should be obvious if a little thought is given to the intended circuit function.

- APO+ . . . auxiliary pickoff, noninverting
- ATTN CLK . . . attenuator clock
- ATTN STRB . . . attenuator strobe
- BDCA . . . bypass delay comparator A
- BDCB . . . bypass delay comparator B
- BPO+ . . . second auxiliary pickoff, noninverting
- BWL . . . bandwidth limit
- BYP . . . bypass
- CC . . . control clock
- CD . . . control data
- CH1 OVL . . . CH1 overload
- CH2 OVL . . . CH2 overload
- CH1 PA CLK . . . CH1 preamp clock
- CH2 PA CLK . . . CH2 preamp clock
- CH1 PRB — CH4 PRB . . . CH1 — CH4 probe encoding
- CONT DATA . . . control data
- CTC . . . capacitor, timing compensation
- DAC MUX1 INH . . . DAC multiplexer 1 inhibit
- DAC MUX1 A0 . . . DAC multiplexer 1, address bit 0
- DAC MUX1 A1 . . . DAC multiplexer 1, address bit 1
- DAC MUX1 A2 . . . DAC multiplexer 1, address bit 2
- DAC MUX1 IN . . . DAC multiplexer 1 input
- DO+ . . . display output, noninverting
- DO— . . . display output, inverting
- DON3 . . . display output, negative CH 3
- DOP3 . . . display output, positive CH 3
- DON4 . . . display output, negative CH 4
- DOP4 . . . display output, positive CH 4
- GA3 . . . gain 3
- GA4 . . . gain 4
- SI . . . scope identification bit
- SIL . . . slow intensity limit
- TPO— . . . trigger pickoff, inverting
- TPO3 . . . CH3 trigger pickoff
- TPO4 . . . CH4 trigger pickoff
- TPT— . . . trigger pickoff reverse termination
- TXY . . . triggered X-Y

TEST WAVEFORM SETUP INFORMATION

The numbered waveforms below were obtained at the test points indicated on the accompanying schematic diagram and board dolly. The waveforms are representative of signals that may be expected at the associated points when the following setup conditions are observed. Any change(s) from the given setup conditions required to produce a given waveform are noted with that waveform illustration.

2445 SETUP

Connect a 200-mV, 1-kHz squarewave signal from a signal generator to the CH 1 and CH 2 inputs of the 2445 via a BNC T-connector, a 50-ohm BNC cable and a dual-input coupler.

TRIGGER MODE AUTO
 SOURCE VERT
 COUPLING DC

All other control settings are irrelevant.

Set:

VERTICAL MODE	CH 1
Input Coupling	
CH 1 and CH 2	1 MΩ DC
VOLTS/DIV	
CH 1 and CH 2	50 mV
A and B SEC/DIV	0.5 ms (knobs locked)

TEST OSCILLOSCOPE SETUP

Connect the 200-mV, 1-kHz squarewave from the BNC T-connector to the External Trigger input of the test oscilloscope using a 50-ohm BNC cable. Externally trigger the test oscilloscope on the rising edge of the 1-kHz signal and, using a X10 probe with the test oscilloscope, set its Volts/Div and Time/Div ranges as required to obtain the indicated displays.

5 6 10 11 16 17

7 12 14 15

8 13

9

18

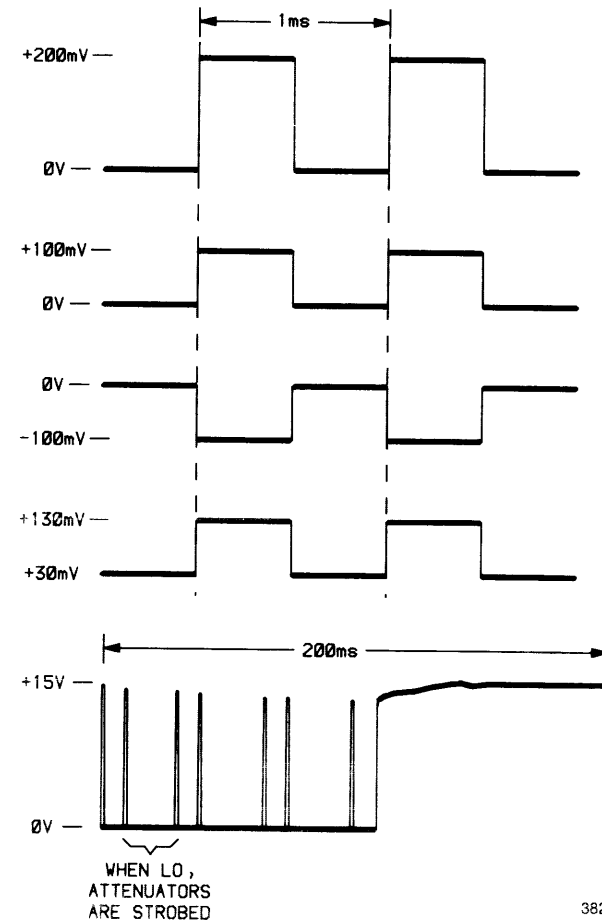

ATTENUATORS AND PREAMPS DIAGRAM

4

ASSEMBLY A1											
CIRCUIT NUMBER	SCHEM LOCATION	BOARD LOCATION	CIRCUIT NUMBER	SCHEM LOCATION	BOARD LOCATION	CIRCUIT NUMBER	SCHEM LOCATION	BOARD LOCATION	CIRCUIT NUMBER	SCHEM LOCATION	BOARD LOCATION
C100	1H	4C	CR150	7F	6C	R114	3N	6D	R329	9L	2D
C103	3G	5C	CR151	7F	6C	R115	3N	6D	R332	9L	2D
C104	2M	5D	CR152	7E	6C	R117	2K	6E	R430	8P	3E
C105	1H	4C	CR153	7E	6C	R118	2L	5E	R440	8K	4F
C115	3P	6E	CR154	4G	6C	R119	2K	6D	R450	2N	3E
C116	3P	7E	CR155	7G	6C	R121	2M	4D	R451	2P	3E
C117	2M	4D	CR160	7L	2D	R123	3C	2H	R452	2N	3E
C118	3S	7E	CR161	7L	2D	R129	6B	5C	R453	2P	3E
C122	2M	5D	CR162	2L	2D	R130	6B	7B	R454	7N	3F
C130	6B	5C	CR163	2L	2D	R131	6C	7B	R455	7N	3E
C175	7K	2D	CR200	8J	3C	R133	5M	6B	R456	7P	3E
C176	7K	2D	CR201	8J	3C	R135	4M	6B	R457	7P	4F
C177	2K	2D	CR460	8S	3E	R136	3B	1H	R458	1S	4F
C179	2K	2D	CR461	8S	3E	R140	6B	7C	R459	7S	4G
C184	9M	2F				R141	6B	7C	R460	8N	3E
C185	9N	3B	J10	2H	5B	R142	5C	7C	R461	8N	3E
C200	8H	3C	J11	8H	3B	R143	6B	7C	R462	8P	4J
C202	7G	4C	J100	1T	4F	R144	5C	7B	R463	8N	3E
C203	8M	4C	J100	7T	4F	R149	4C	7B	R464	8S	3E
C205	7H	3C	J100	8K	4F	R159	7K	1D	R465	8P	3F
C206	7M	4D	J103	8L	4C	R161	7L	2D	R502	3B	1G
C217	7K	2D	J105	8T	3E	R162	2K	2D			
C222	7M	4D	J110	6T	2E	R163	2K	2D	U100	2M	5D
C301	10B	1B	J111	4N	6B	R190	3J	2E	U110	4E	6B
C302	10B	3B	J117	2P	6E	R191	3J	2E	U120	6E	6C
C310	8H	1C	J181	5P	6B	R192	4J	2E	U130A	5G	6C
C311	2H	1C	J511	10T	1D	R193	4J	1E	U130B	5G	6C
C329	9L	2D	J511	9B	1D	R194	3J	1H	U130C	5K	6C
C332	9L	2D	J512	3A	1H	R195	8N	2E	U130D	5M	6C
C450	2P	3F				R196	8M	2E	U130E	5M	6C
C454	7P	3F	L115	3P	6E	R197	9M	2F	U130F	4M	6C
C460	8P	3E				R198	9M	3F	U130G	6B	6C
C464	8S	3E	LR180	2N	4E	R199	9M	3F	U140	5D	7B
			LR280	7N	3E	R200	8H	3C	U150	6D	7C
CR100	1J	5C				R201	8H	3B	U160A	2L	2D
CR101	1J	5C	P100A	2T	4F	R202	8H	3B	U160B	6L	2D
CR130	6C	7B	P100D	7T	4F	R216	7L	3D	U160C	7K	2D
CR131	6C	7B	P103	8L	4C	R217	7K	3D	U160D	1K	2D
CR140	4G	6B				R218	7K	3E	U165A	8M	2F
CR141	4F	6B	Q130	6C	7B	R219	7L	3D	U170	4J	2E
CR142	4F	6B	Q131	6C	7B	R223	3C	2H	U200	7M	4D
CR143	4F	6B	Q190	8N	3E	R230	3D	2E	U300	10M	2B
CR144	4F	6B	Q460A	8P	3E	R231	3B	2E	U450A	7P	3F
CR145	4E	6B	Q460B	8P	3E	R232	3C	3E	U450B	2P	3F
CR146	4E	6B				R301	10A	1A	W171	7L	2D
CR147	7G	6C	R100	1H	4C	R302	10A	2A	W172	1L	2D
CR148	7F	6C	R101	1H	5B	R304	10A	1B	W194	3J	2E
CR149	7F	6C	R102	2H	5B	R311	10A	2A			

Partial A1 also shown on diagrams 5, 6, 8 and 11.

ASSEMBLY A8

CIRCUIT NUMBER	SCHEM LOCATION	BOARD LOCATION	CIRCUIT NUMBER	SCHEM LOCATION	BOARD LOCATION	CIRCUIT NUMBER	SCHEM LOCATION	BOARD LOCATION	CIRCUIT NUMBER	SCHEM LOCATION	BOARD LOCATION
DS100	5S	1M	DS102	5S	1P	P181	5S	1P	W181	5S	1P
DS101	5S	1N									

ASSEMBLY A11

CIRCUIT NUMBER	SCHEM LOCATION	BOARD LOCATION	CIRCUIT NUMBER	SCHEM LOCATION	BOARD LOCATION	CIRCUIT NUMBER	SCHEM LOCATION	BOARD LOCATION	CIRCUIT NUMBER	SCHEM LOCATION	BOARD LOCATION
J1	1A	5A	P10	1H	5B	W10	2H	5B			

ASSEMBLY A12 CHASSIS MOUNTED PARTS

CIRCUIT NUMBER	SCHEM LOCATION	BOARD LOCATION	CIRCUIT NUMBER	SCHEM LOCATION	BOARD LOCATION	CIRCUIT NUMBER	SCHEM LOCATION	BOARD LOCATION	CIRCUIT NUMBER	SCHEM LOCATION	BOARD LOCATION
J2	8A	3A	J3	10A	CHASSIS	P111	4N	CHASSIS	W111	5N	CHASSIS
P11	8H	3B	J4	10A	CHASSIS	R134	5N	CHASSIS			
W11	9H	3B	J5	8T	CHASSIS						

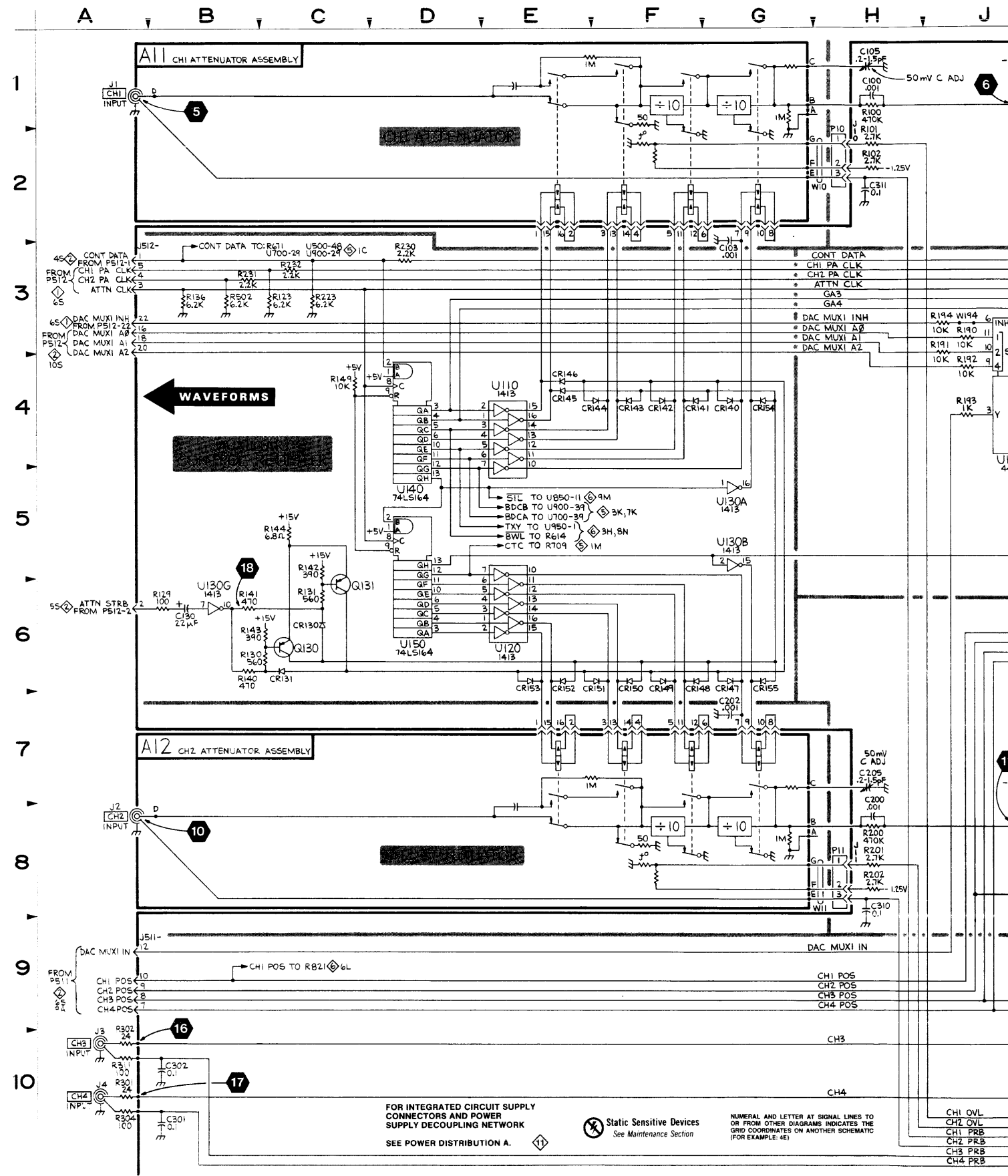

2445

A B C D E F G H J K L M N P S T

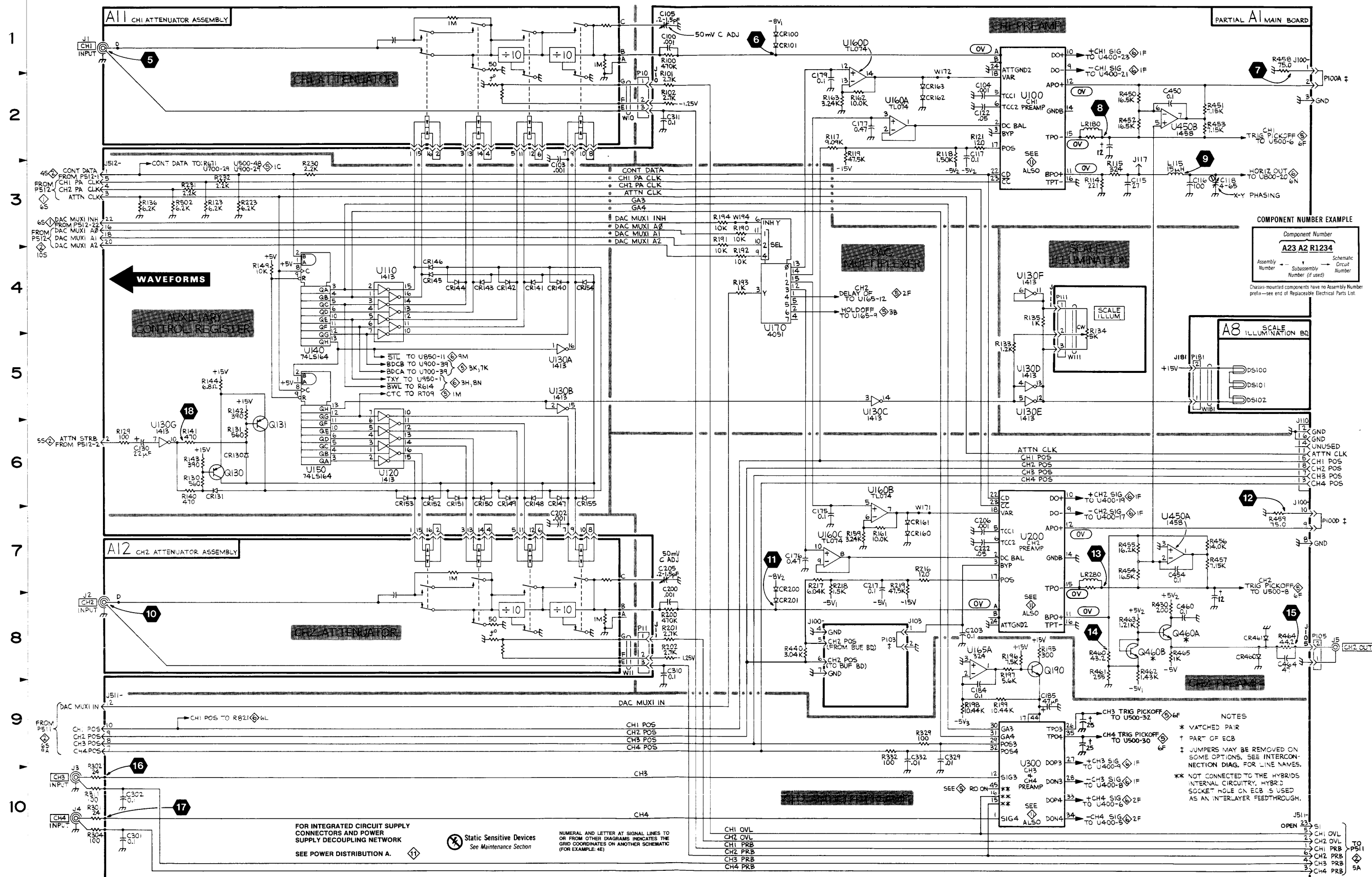

SCHEM LOCATION	BOARD LOCATION
9L	2D
9L	2D
8P	3E
8K	4F
2N	3E
2P	3E
2N	3E
2P	3E
7N	3F
7N	3E
7P	3E
7P	4F
1S	4F
7S	4G
8N	3E
8N	3E
8P	4J
8N	3E
8S	3F
8P	3E
3B	1G
2M	5D
4E	6B
6E	6C
5G	6C
5G	6C
5K	6C
5M	6C
5M	6C
4M	6C
6B	6C
5D	7B
6D	7C
2L	2D
6L	2D
7K	2D
1K	2D
8M	2F
4J	2E
7M	4D
10M	2B
7P	3F
2P	3F

SCHEM LOCATION	BOARD LOCATION
5S	1P

SCHEM LOCATION	BOARD LOCATION

SCHEM LOCATION	BOARD LOCATION
5N	CHASSIS

2445

3829-75

ATTENUATORS AND PREAMPS

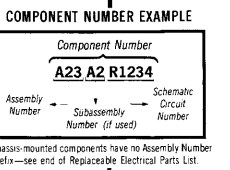

Chassis-mounted components have no Assembly Number prefix—see end of Replaceable Electrical Parts List.

- NOTES
- * MATCHED PAIR
 - † PART OF ECB
 - ‡ JUMPERS MAY BE REMOVED ON SOME OPTIONS. SEE INTERCONNECTION DIAG. FOR LINE NAMES.
 - ** NOT CONNECTED TO THE HYBRIDS INTERNAL CIRCUITRY. HYBRID SOCKET HOLE ON ECB IS USED AS AN INTER-LAYER FEEDTHROUGH.

FOR INTEGRATED CIRCUIT SUPPLY CONNECTORS AND POWER SUPPLY DECOUPLING NETWORK SEE POWER DISTRIBUTION A.

Static Sensitive Devices See Maintenance Section

NUMERAL AND LETTER AT SIGNAL LINES TO OR FROM OTHER DIAGRAMS INDICATES THE GRID COORDINATES ON ANOTHER SCHEMATIC (FOR EXAMPLE: 4E)

- CHI OVL
- CH2 OVL
- CHI PRB
- CH2 PRB
- CH3 PRB
- CH4 PRB

TEST WAVEFORM SETUP INFORMATION

The numbered waveforms below were obtained at the test points indicated on the accompanying schematic diagram and board dolly. The waveforms are representative of signals that may be expected at the associated points when the following setup conditions are observed. Any change(s) from the given setup conditions required to produce a given waveform are noted with that waveform illustration. Where B Sweep setup conditions are referenced with a waveform, it is assumed that the B SEC/DIV knob is set to 100 μ s/div unless otherwise noted.

2445 SETUP

Connect a 200-mV, 1-kHz squarewave to the CH 1 input of the 2445 using a BNC cable.

Set:

VERTICAL MODE CH 1

Input Coupling CH 1 and CH 2 1 M Ω DC

VOLTS/DIV CH 1 and CH 2 50 mV
CH 1 and CH 2 VAR In detent

A and B SEC/DIV 0.2 ms (knobs locked)

A and B SEC/DIV VAR In detent

TRIGGER MODE AUTO
SOURCE VERT
COUPLING NOISE REJ
HOLDOFF In detent
SLOPE + (plus)
LEVEL Stably triggered display

Δt DLY readout
 Δ REF OR DLY POS 1000.0 μ s readout
INTENSITY Midrange
READOUT INTENSITY Minimum (once DLY readout is set)
All other control settings are irrelevant.

TEST OSCILLOSCOPE SETUP

Using a X10 probe with the test oscilloscope, set its Trigger Slope, Trigger Level, Volts/Div and Time/Div ranges as required to obtain the indicated displays.

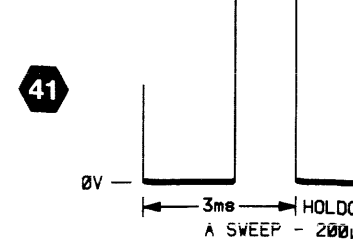
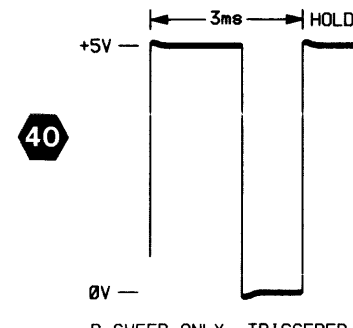
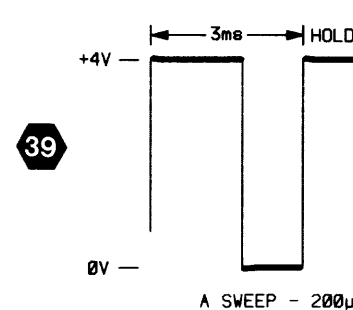
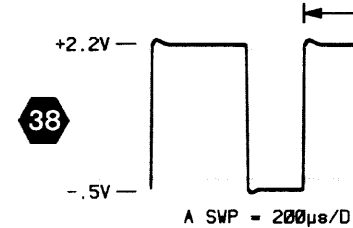
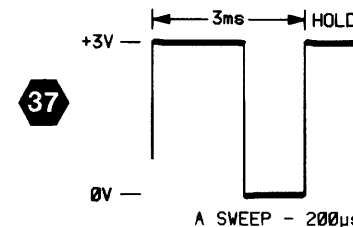
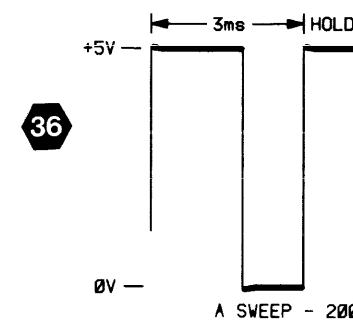
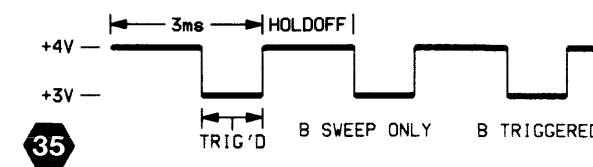
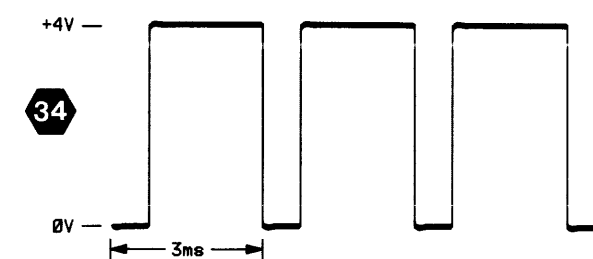
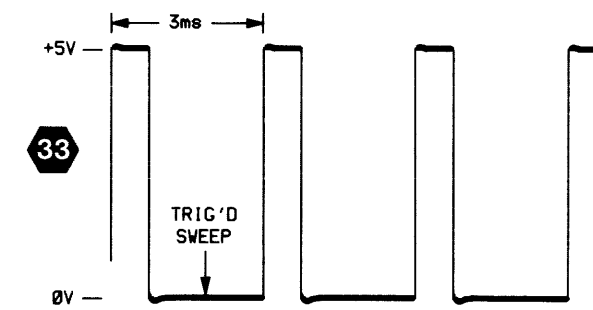
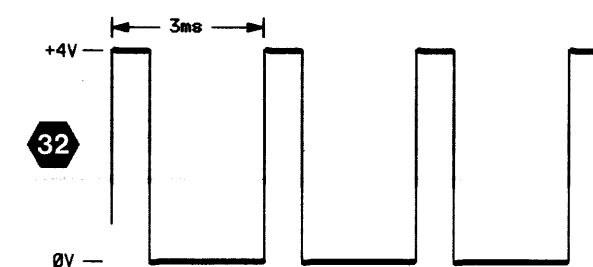
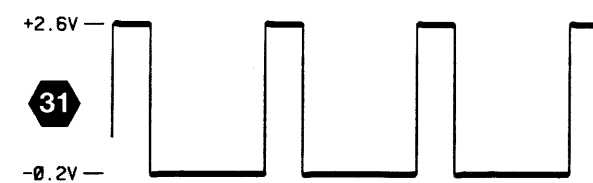
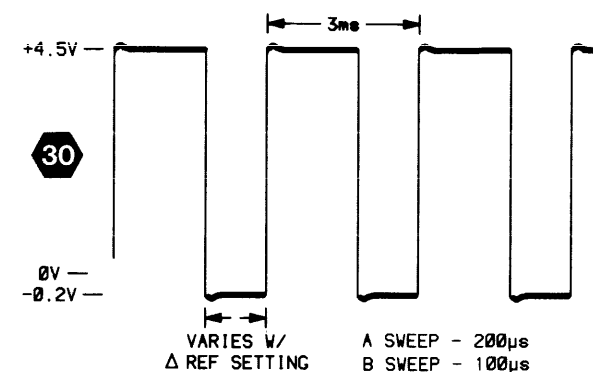
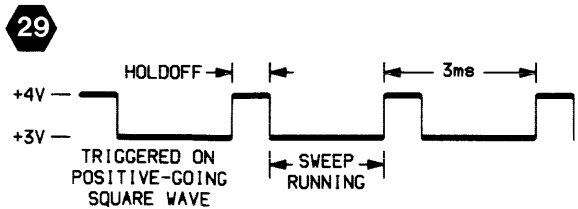
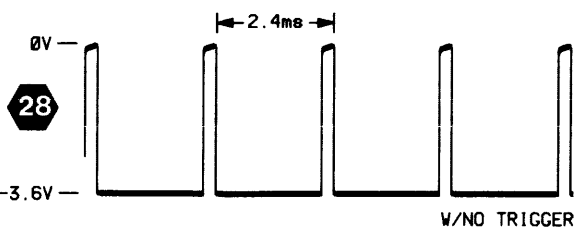
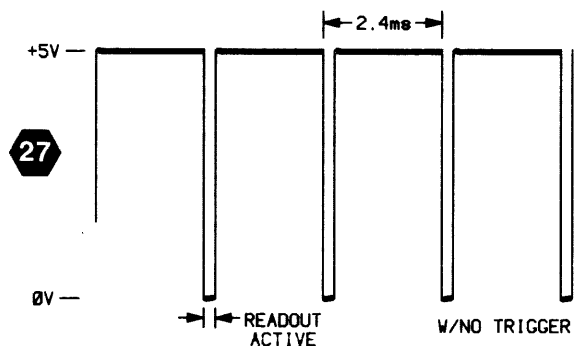
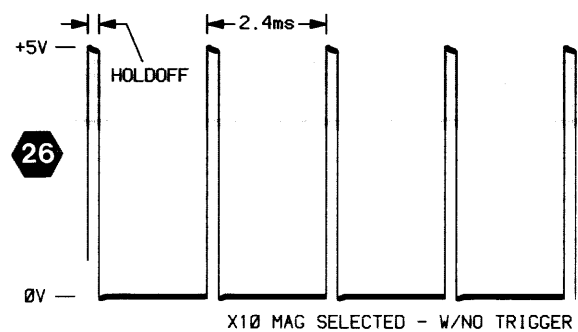
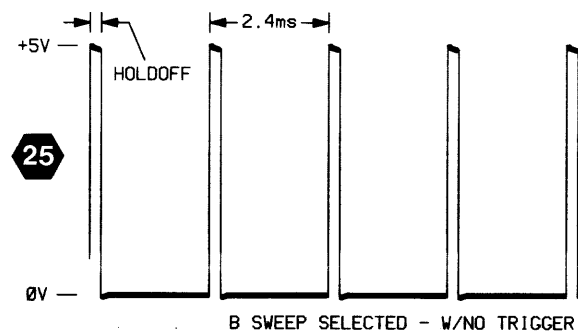
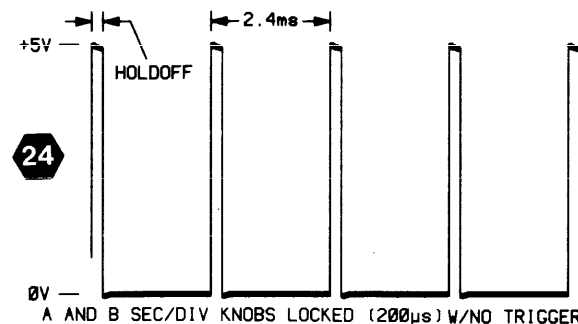
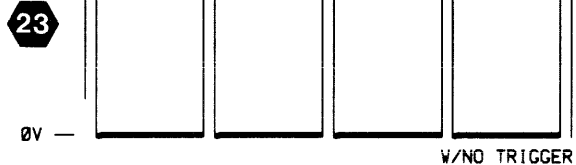
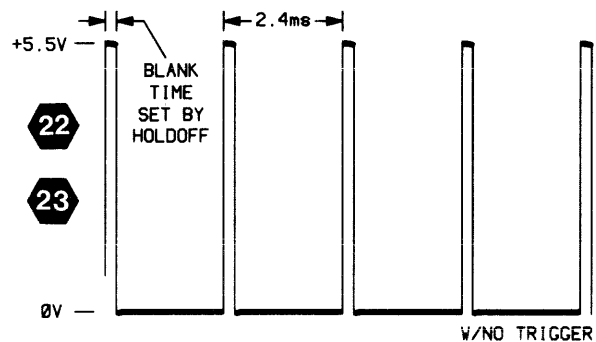
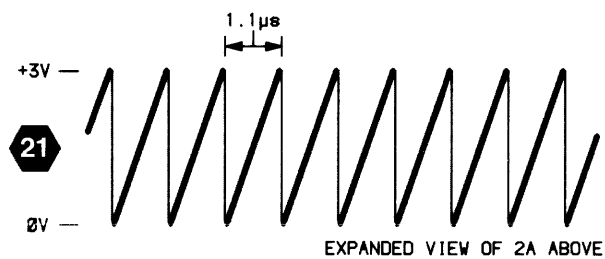
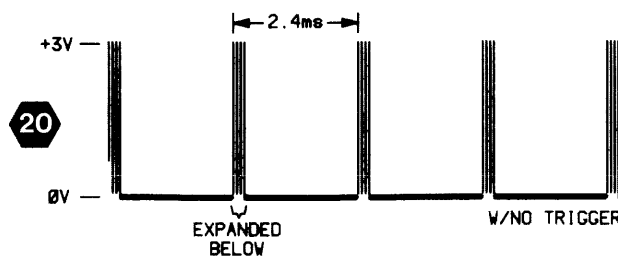
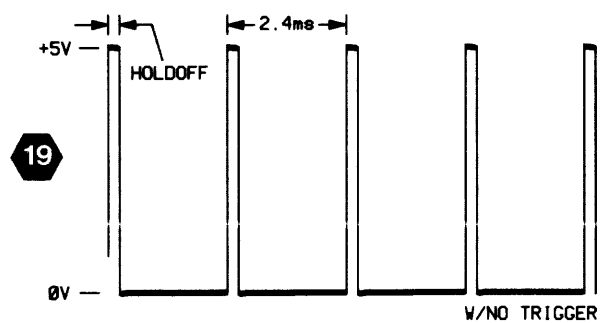
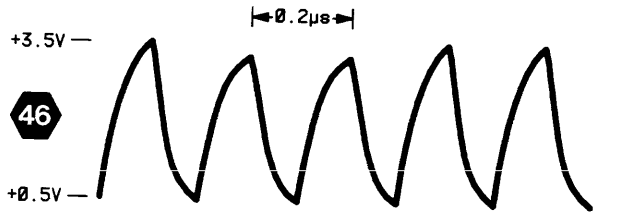
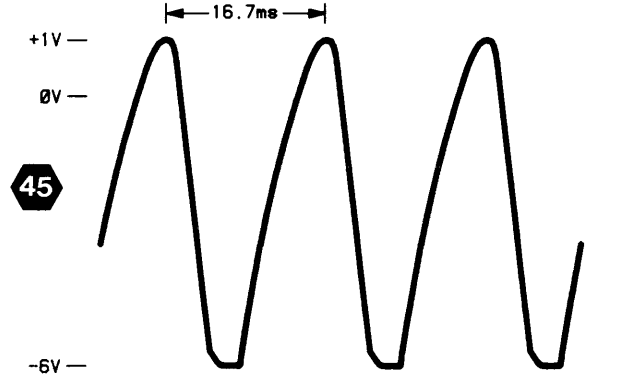
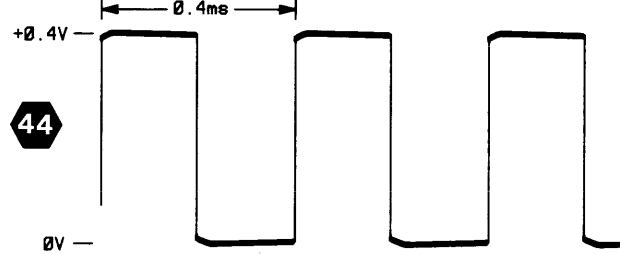
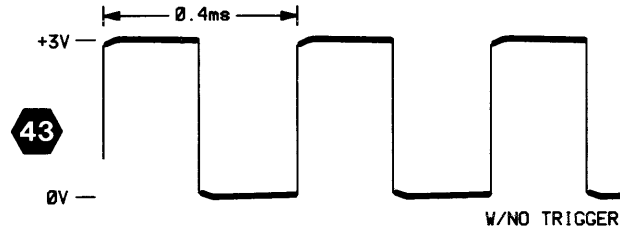
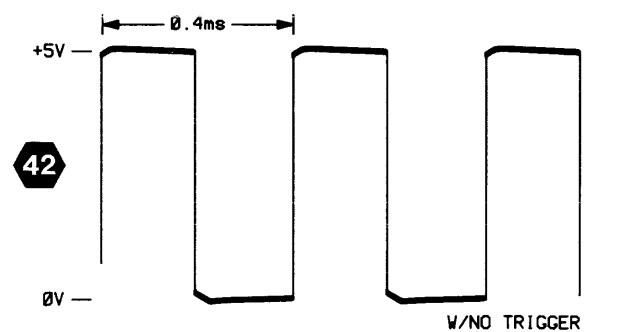
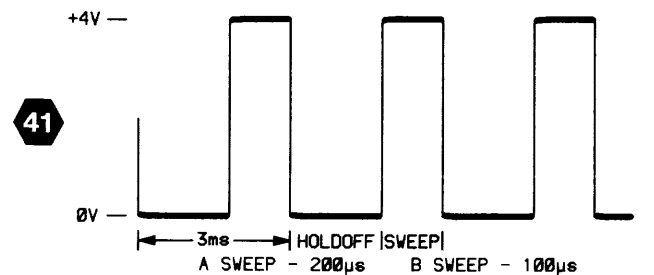
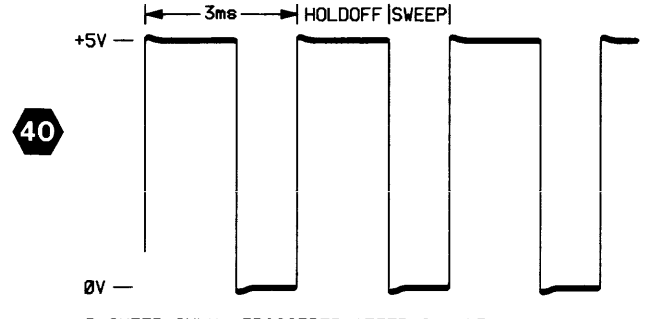
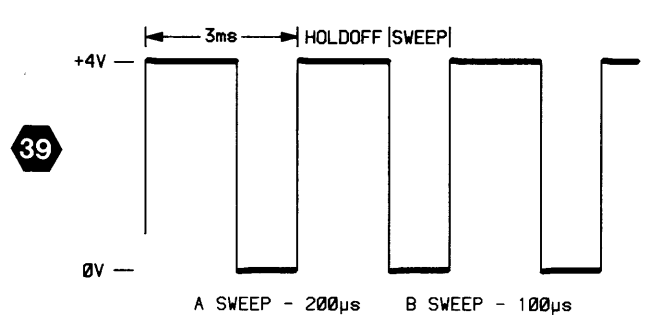
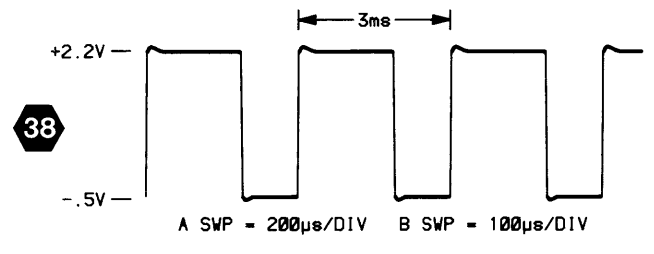
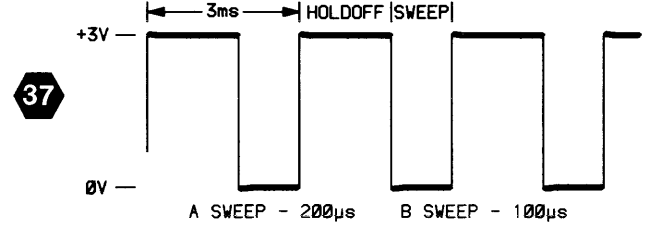
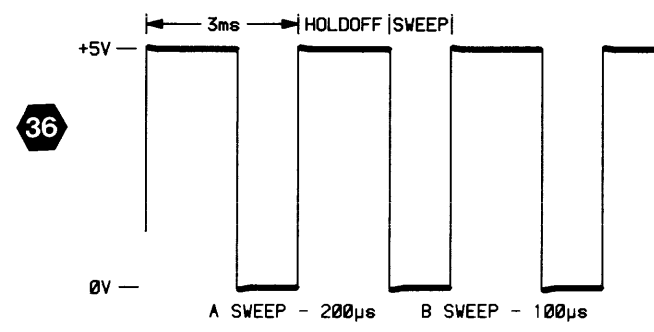
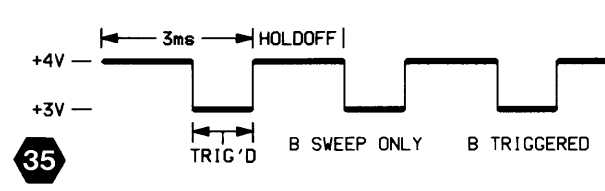
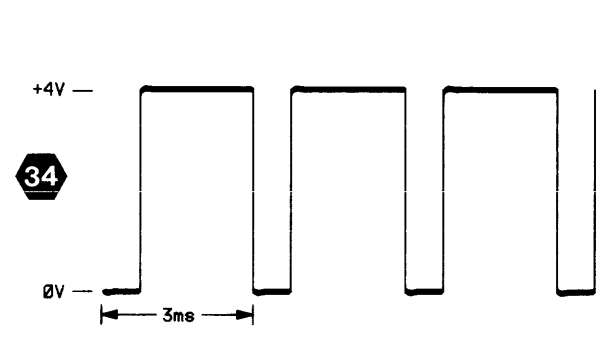
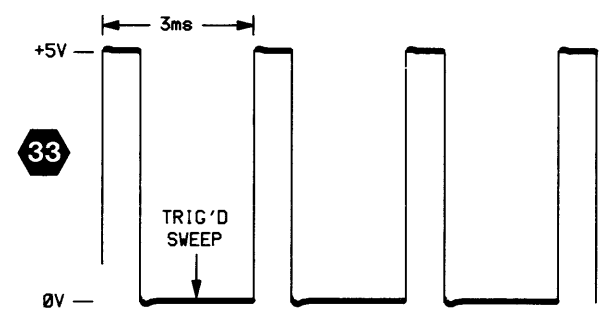
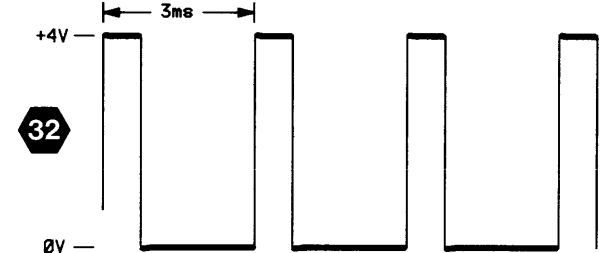
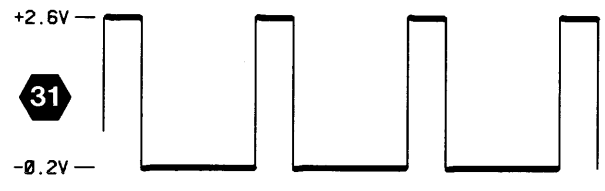
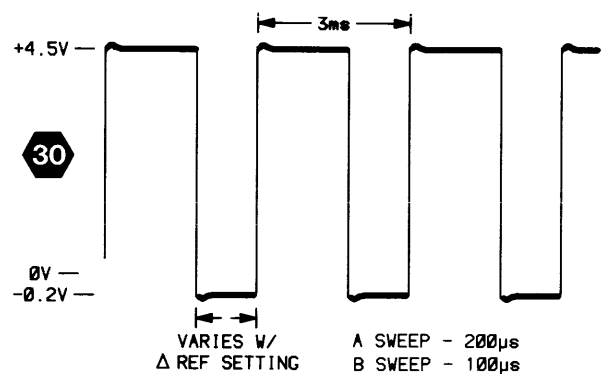
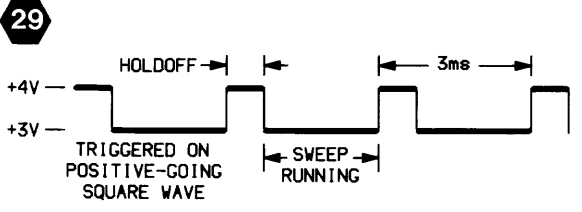
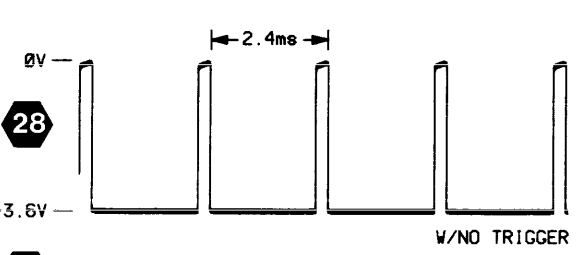
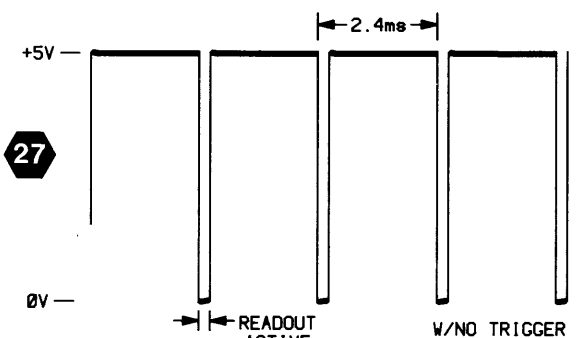
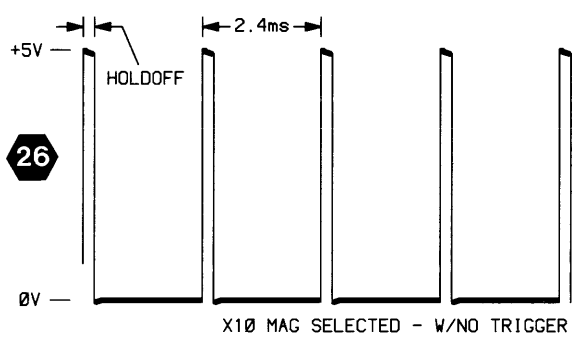
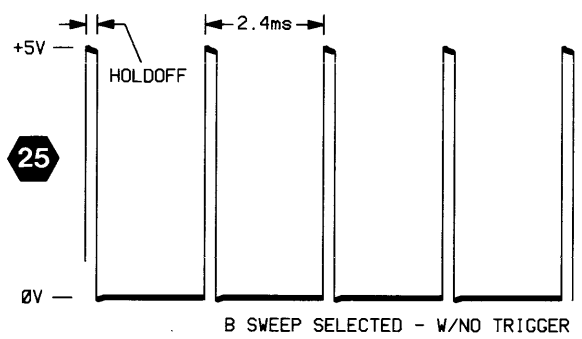
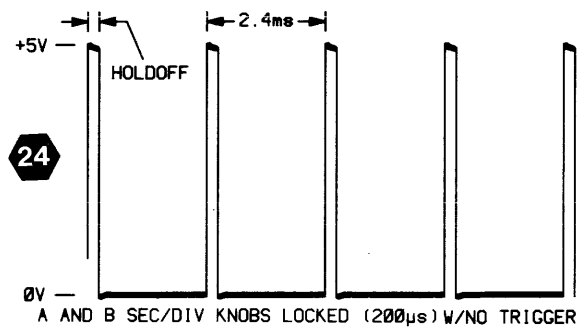

Diagram and following waveform are assumed that



set its Div ranges

2A ABOVE

TRIGGER

ACRONYM DICTIONARY

The following listing explains some of the less obvious acronyms and signal labels used on this schematic. Acronyms and labels not shown in this listing may be included in the circuit descriptions (Section 3) and should be obvious if a little thought is given to the intended circuit function.

ACA . . . A low-pass capacitor	$\overline{\text{ROR}}$. . . readout request
ACB . . . B low-pass capacitor	SDO . . . sweep delay offset
AHO . . . A holdoff	$\overline{\text{SG}}$. . . sweep gate
A TIM REF . . . A timing reference	SGA . . . sweep gate A
B TIM REF . . . B timing reference	$\overline{\text{SGAZ}}$. . . sweep gate A to Z axis
BDC . . . bypass delay comparator	$\overline{\text{SGB}}$. . . sweep gate B
BDCA . . . bypass delay comparator A	$\overline{\text{SGBZ}}$. . . sweep gate B to Z axis
BDCB . . . bypass delay comparator B	$\overline{\text{SR0A}}$. . . A trigger source select 0
BWL B . . . bandwidth limited B signal	$\overline{\text{SR1A}}$. . . A trigger source select 1
CAL . . . calibrator	$\overline{\text{SR2A}}$. . . A trigger source select 2
CAL OUT . . . calibrator out	$\overline{\text{SR0B}}$. . . B trigger source select 0
$\overline{\text{CC}}$. . . control clock	$\overline{\text{SR1B}}$. . . B trigger source select 1
$\overline{\text{CCA}}$. . . control clock A	$\overline{\text{SR2B}}$. . . B trigger source select 2
$\overline{\text{CCB}}$. . . control clock B	SSA . . . A selected signal source
CD . . . control data	SSB . . . B selected signal source
CHN5A . . . CH5 (for A trigger)	SSR . . . sweep start reference
CHN5B . . . CH5 (for B trigger)	$\overline{\text{STBA}}$. . . A compare strobe
CONT DATA . . . control data	$\overline{\text{STBB}}$. . . B compare strobe
CT . . . calibrator timing out	TC . . . timing clock
CTC . . . capacitor, timing compensation	TCS . . . timing capacitor select
CT0 . . . timing capacitor 0	$\overline{\text{TGA}}$. . . A trigger
CT2 . . . timing capacitor 2	TGA . . . inverted A trigger
DG . . . delay gate	TGB . . . B trigger
DGB . . . delay gate bypass	$\overline{\text{TGB}}$. . . inverted B trigger
DI . . . display intensity	THO . . . trigger holdoff
DOR . . . delay offset reference	THOA . . . trigger holdoff A
DR . . . delay reference	THOB . . . trigger holdoff B
$\overline{\text{DS}}$. . . delay select	TLA . . . trigger level A
HRR . . . holdoff ramp reset	TLB . . . trigger level B
$\overline{\text{HSA}}$. . . horizontal select A	TRIG STAT STRB . . . trigger status strobe
HSB . . . horizontal select B	$\overline{\text{TSA}}$. . . trigger status A
IREF . . . current reference	$\overline{\text{TSB}}$. . . trigger status B
IT . . . timing current	TS IN . . . trace separation input
ITF . . . timing current feedback	TSO . . . trigger status output
ITR . . . timing current reference	$\overline{\text{TSS}}$. . . trigger status strobe
ITREF . . . timing current reference	TS1 . . . trace separation voltage 1
ITRR . . . timing current reference return	TS2 . . . trace separation voltage 2
IZD . . . inhibit zero delay	TS1+TS2 . . . trace separation 1 and 2
RDA . . . reset delay adjust	VBBI . . . bias voltage in
$\overline{\text{ROA}}$. . . readout acknowledge	$\overline{\text{VBBO}}$. . . bias voltage out
$\overline{\text{ROB}}$. . . readout blank	VS1 – VS4 . . . vertical selects 1 – 4
ROI . . . readout intensity	
RO ON . . . readout on	

5

SCHEM LOCATION	BOARD LOCATION
6M	7H
5K	9F
5K	9E
5K	7G
6K	9F
6K	8G
7M	6K
7M	9J
6M	9H
7M	8J
6M	7J
7P	6K
6E	7K
4P	5K
8N	2F
3C	2F
2G	2F
6C	8B
1N	8B
7G	2G
9P	1F
8P	1F
8P	1F
8N	1F
9P	1F
6D	3J
3L	7D
6J	8F
3J	8F
3M	6F
2J	6F
6L	8H
5K	9F
2K	9F
4P	6K
7P	6K
4N	6K
6M	6K
8N	1E
7S	6K
3S	5K
8A	4H
8E	1J
2E	2J

SCHEM LOCATION	BOARD LOCATION
6A	CHASSIS
6A	CHASSIS

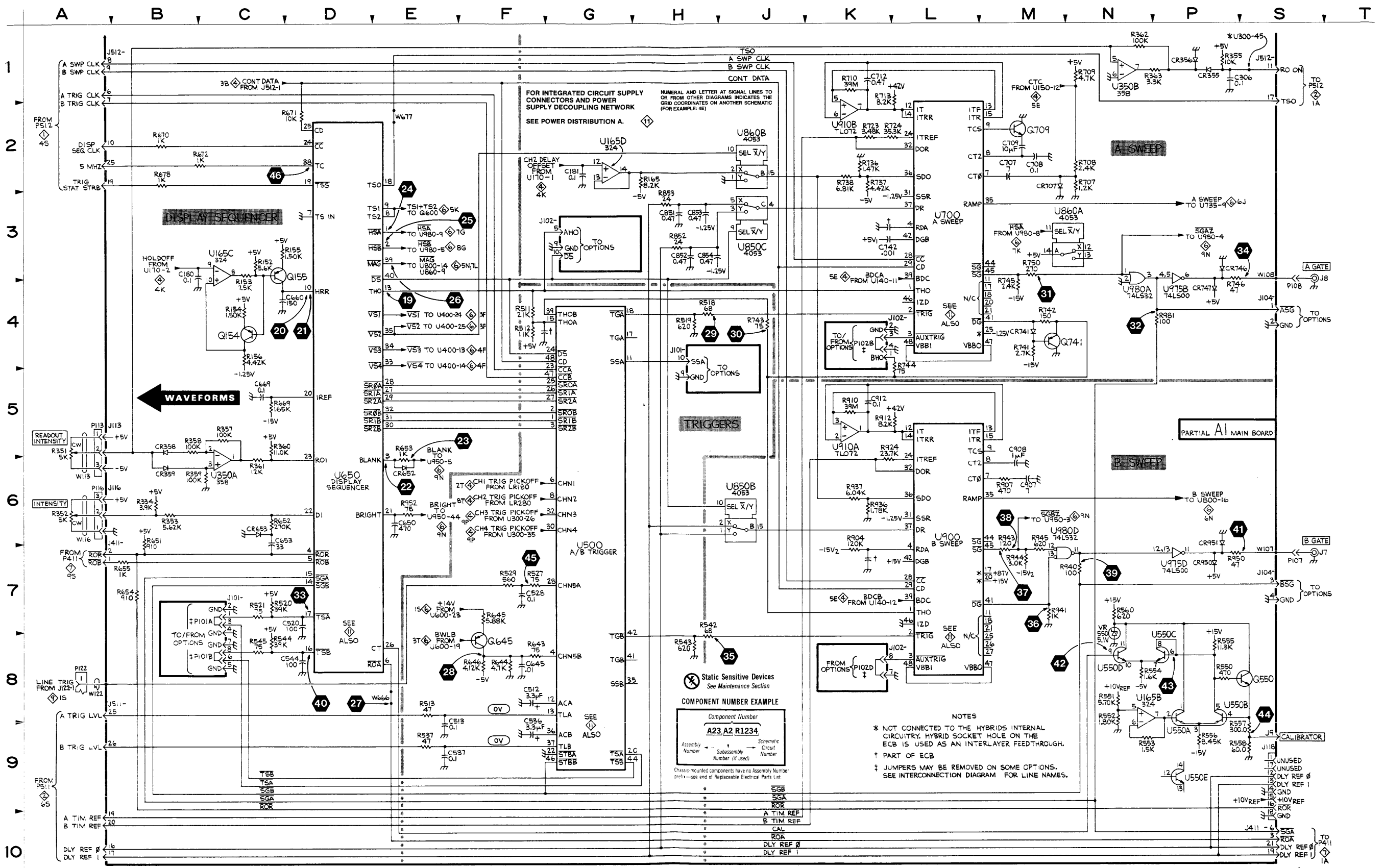

5

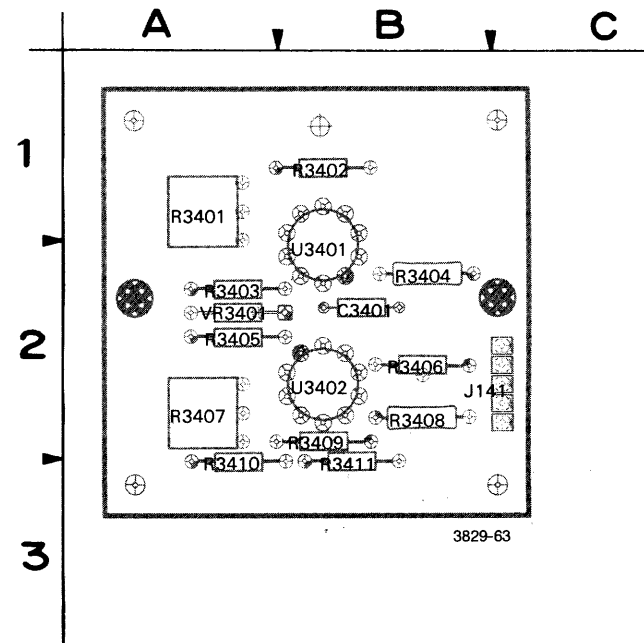
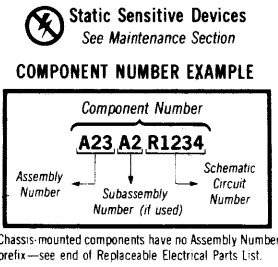
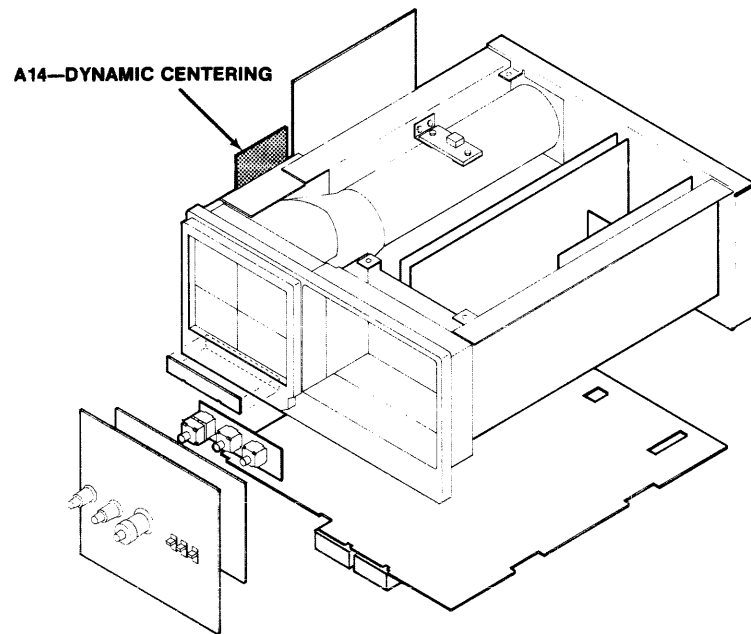

Figure 9-9. A14—Dynamic Centering board.



ALL COMPONENTS MOUNTED ON A14—DYNAMIC CENTERING BOARD ARE SHOWN ON SCHEMATIC DIAGRAM 6.



TEST WAVEFORM SETUP INFORMATION

The numbered waveforms below were obtained at the test points indicated on the accompanying schematic diagram and board dolly. The waveforms are representative of signals that may be expected at the associated points when the following setup conditions are observed. Any change(s) from the given setup conditions required to produce a given waveform are noted with that waveform illustration. Where B Sweep setup conditions are referenced with a waveform, it is assumed that the B SEC/DIV knob is set to 100 μ s/div unless otherwise noted.

2445 SETUP

Connect a 200-mV, 1-kHz squarewave to the CH 1 input of the 2445 using a BNC cable.

Set:

- VERTICAL MODE CH 1
- Input Coupling CH 1 and CH 2 1 M Ω DC
- VOLTS/DIV CH 1 and CH 2 50 mV
- CH 1 and CH 2 VAR In detent
- A and B SEC/DIV 0.2 ms (knobs locked)
- A and B SEC/DIV VAR In detent

- TRIGGER MODE AUTO
- SOURCE VERT
- COUPLING NOISE REJ
- HOLDOFF In detent
- SLOPE + (plus)
- LEVEL Stably triggered display

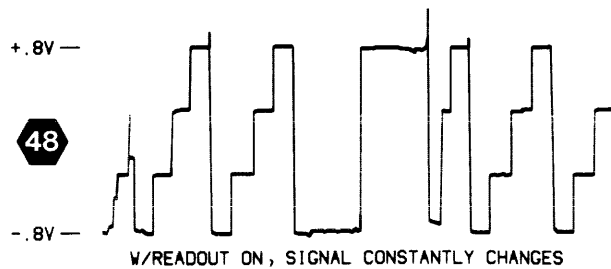
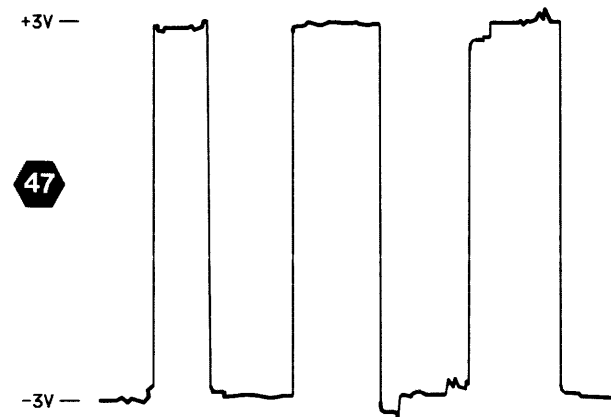

- Δ t DLY readout
 - Δ REF OR DLY POS 1000.0 μ s readout
 - INTENSITY Midrange
 - READOUT INTENSITY Minimum (once DLY readout is set)
- All other control settings are irrelevant.

TEST OSCILLOSCOPE SETUP

Using a X10 probe with the test oscilloscope, set its Trigger Slope, Trigger Level, Volts/Div and Time/Div ranges as required to obtain the indicated displays.

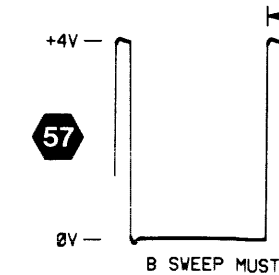
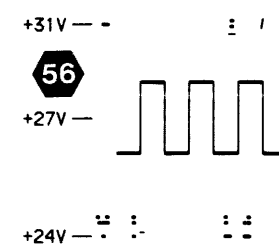
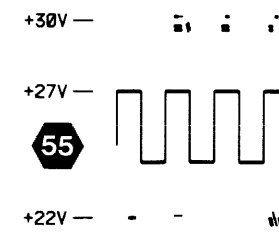
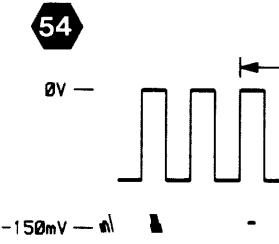
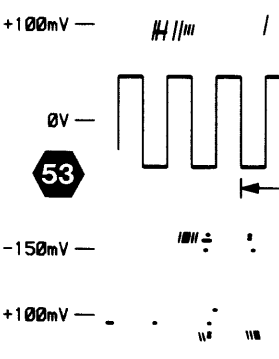
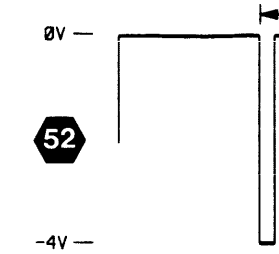
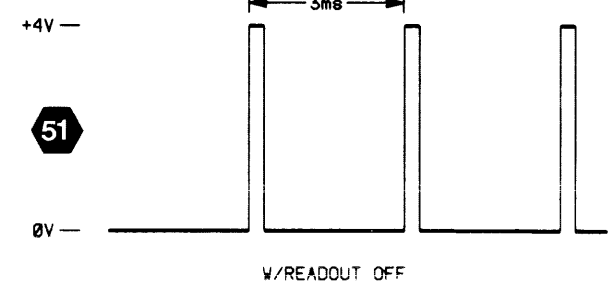
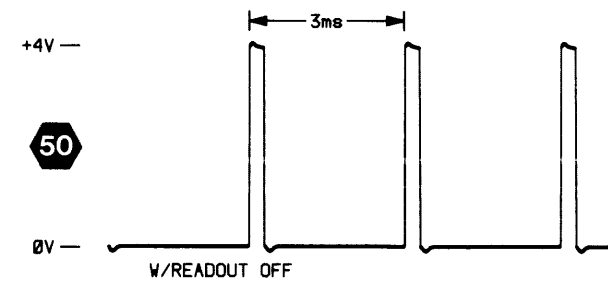
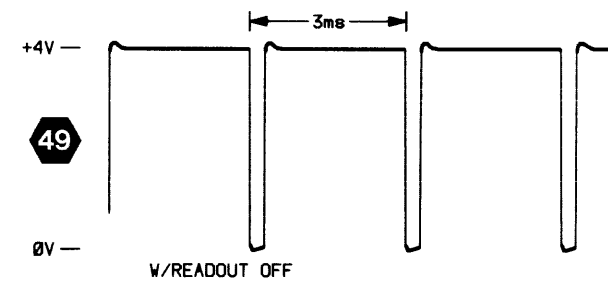

TEST WAVEFORM SETUP INFORMATION

The numbered waveforms below were obtained at the test points indicated on the accompanying schematic diagram and board dolly. The waveforms are representative of signals that may be expected at the associated points when the following setup conditions are observed. Any change(s) from the given setup conditions required to produce a given waveform are noted with that waveform illustration. Where B Sweep setup conditions are referenced with a waveform, it is assumed that the B SEC/DIV knob is set to 100 μ s/div unless otherwise noted.

2445 SETUP

Connect a 200-mV, 1-kHz squarewave to the CH 1 input of the 2445 using a BNC cable.

Set:

VERTICAL MODE CH 1
 Input Coupling CH 1 and CH 2 1 M Ω DC
 VOLTS/DIV CH 1 and CH 2 50 mV
 CH 1 and CH 2 VAR In detent

A and B SEC/DIV 0.2 ms (knobs locked)

A and B SEC/DIV VAR In detent

TRIGGER MODE AUTO
 SOURCE VERT
 COUPLING NOISE REJ
 HOLDOFF In detent
 SLOPE + (plus)
 LEVEL Stably triggered display

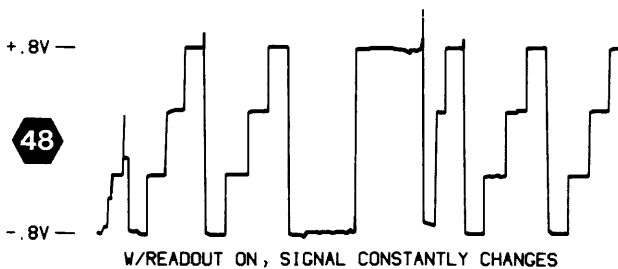
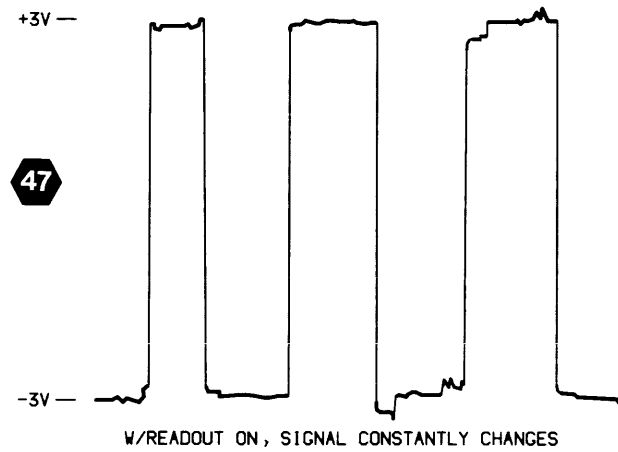

Δt DLY readout
 Δ REF OR DLY POS 1000.0 μ s readout
 INTENSITY Midrange
 READOUT INTENSITY Minimum (once DLY readout is set)

All other control settings are irrelevant.

TEST OSCILLOSCOPE SETUP

Using a X10 probe with the test oscilloscope, set its Trigger Slope, Trigger Level, Volts/Div and Time/Div ranges as required to obtain the indicated displays.

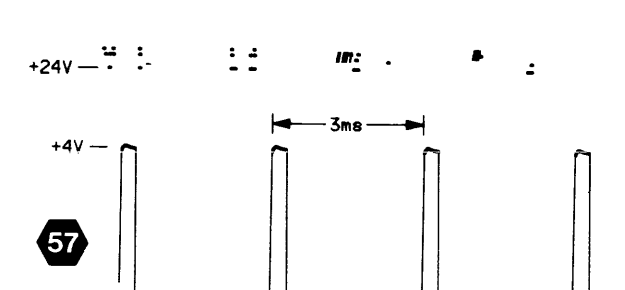
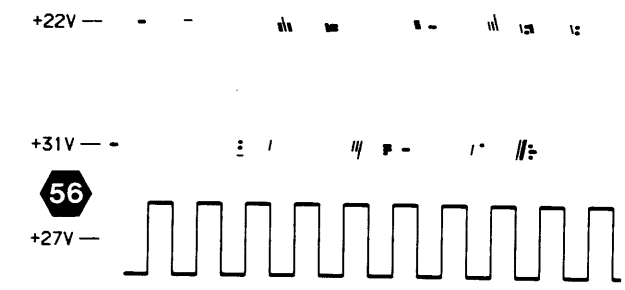
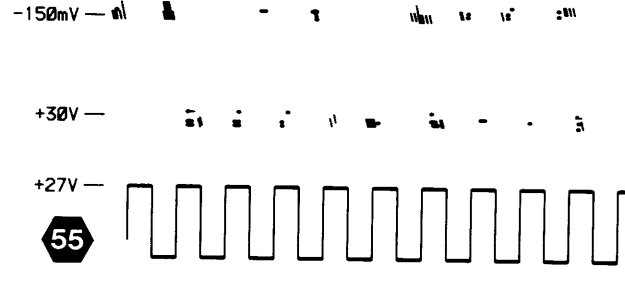
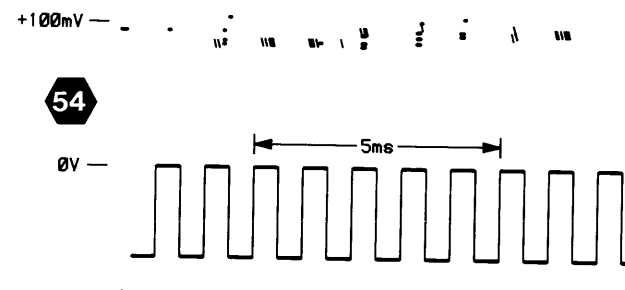
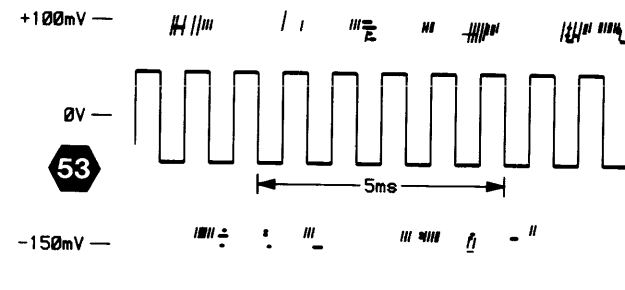
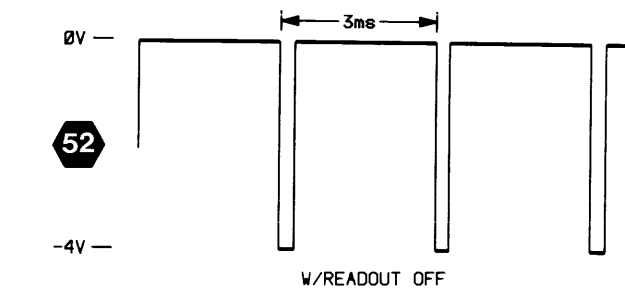
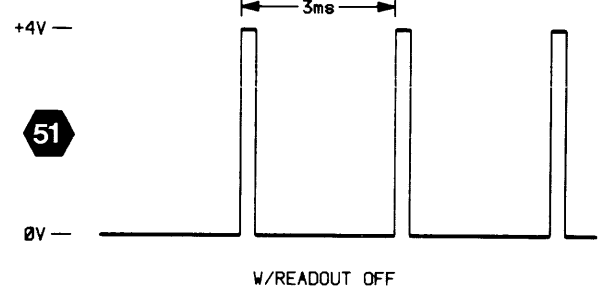
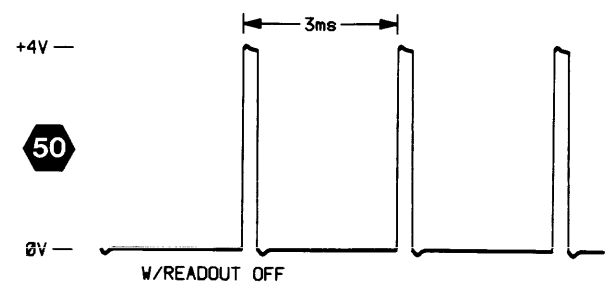
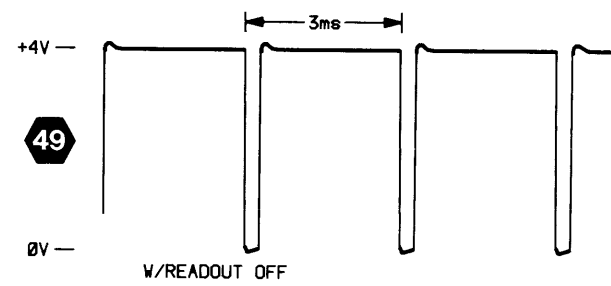

B SWEEP MUST BE SELECTED

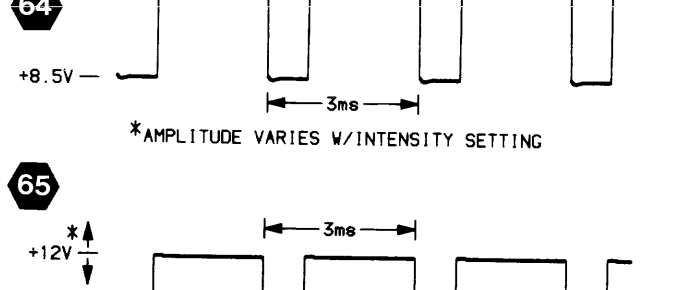
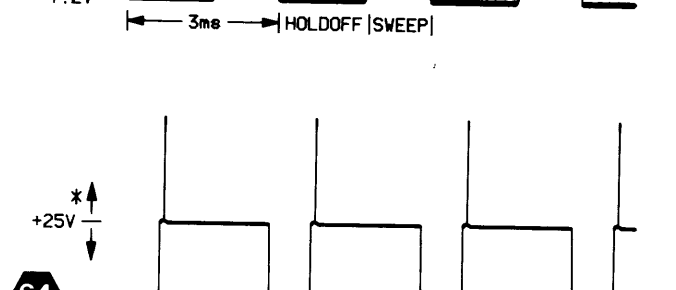
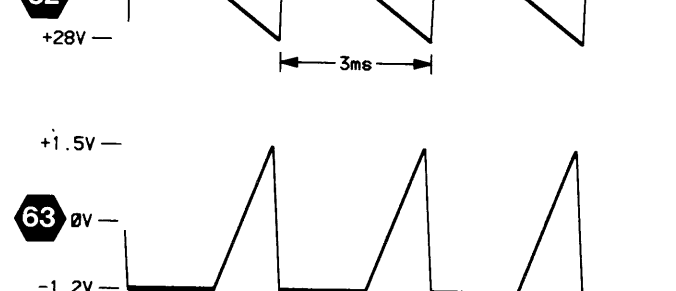
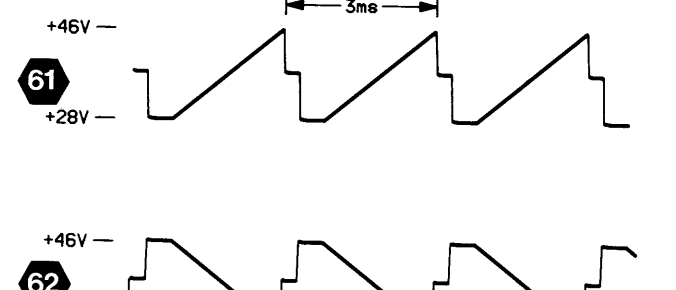
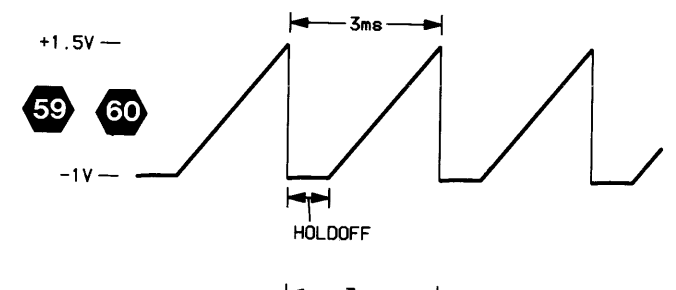
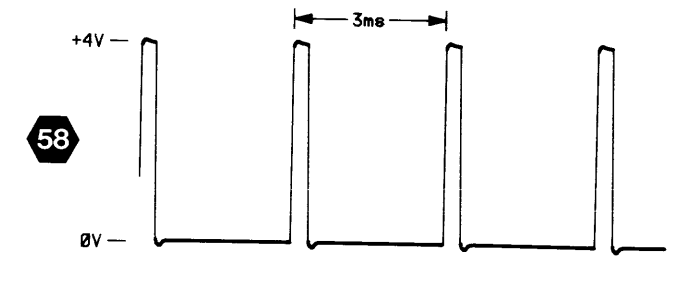

*AMPLITUDE VARIES W/INTENSITY SETTING

*AMPLITUDE VARIES W/INTENSITY SETTING

ACRONYM DICTIONARY

The following listing explains some of the less obvious acronyms and signal labels used on this schematic. Acronyms and labels not shown in this listing may be included in the circuit descriptions (Section 3) and should be obvious if a little thought is given to the intended circuit function.

A+ . . . A sweep
 B+ . . . B sweep
 BD0 . . . buffered data bit 0
 BF . . . beamfind
 BTST . . . bootstrap
 BWL . . . bandwidth limit
 BWLA1 . . . A bandwidth limit inductor input
 BWLA2 . . . A bandwidth limit inductor output
 BWLB . . . bandwidth limit B
 BWLB1 . . . B bandwidth limit inductor input
 BWLB2 . . . B bandwidth limit inductor output
 CLB . . . current limit bypass
 CMB . . . common mode bypass
 COMP A . . . A compensation
 COMP B . . . B compensation
 GA . . . gain
 GADJ . . . gain adjust
 HSA . . . horizontal select A
 HSB . . . horizontal select B
 I BIAS . . . current reference
 ISRC . . . current source
 MKL RC . . . mean cathode loading RC
 MREG . . . mag registration
 Q GAIN . . . quadrapole gain
 RO DO . . . readout data out
 ROSFRAME . . . readout subframe
 R/W DLYD . . . read/write delayed
 RO . . . readout
 ROS1 . . . readout strobe 1
 ROS2 . . . readout strobe 2
 SGA . . . sweep gate A
 SGAZ . . . sweep gate A to Z-axis
 SGB . . . sweep gate B
 SGAB . . . sweep gate B to Z-axis
 SIL . . . slow intensity limit
 TADJ . . . thermal adjust
 TRANR . . . transient response
 TRANS RESP . . . transient response
 TRQ . . . transient response, quadrapole drive
 TRZ . . . transient response, Z-axis
 TS . . . trace separation
 TS1+TS2 . . . trace separation inputs 1 and 2
 TXY . . . triggered X-Y
 VZOUT . . . variable Z-axis output
 VQOUT . . . variable quadrapole output
 VS1 – VS4 . . . vertical selects 1 – 4
 X+ . . . noninverting external input
 X– . . . inverting external input

CHANNEL SWITCH AND OUTPUT AMPLIFIERS DIAGRAM

6

ASSEMBLY A1											
CIRCUIT NUMBER	SCHEM LOCATION	BOARD LOCATION	CIRCUIT NUMBER	SCHEM LOCATION	BOARD LOCATION	CIRCUIT NUMBER	SCHEM LOCATION	BOARD LOCATION	CIRCUIT NUMBER	SCHEM LOCATION	BOARD LOCATION
C402	3F	5F	L609	2M	5H	R500	10B	1J	R956	8N	7K
C404	2K	5J	L610	2M	5H	R501	10B	1J	R957	8N	7J
C412	2F	4F	L611	2L	5H	R600	3P	6J	R972	9S	9K
C478	3E	3J	L612	2L	5H	R601	2N	5H	R973	9P	9K
C488	2C	3K	L619	3P	6G	R602	2N	5H	R995	9B	7K
C488	2B	3K	L644	3P	6J	R605	2N	5H			
C617	3M	5G				R606	2M	5H	S615	4M	8B
C625	1P	6G	P106	9A	7K	R607	2M	5G			
C735	6K	7E	P141	5F	9K	R608	2M	4H	U400	2G	5E
C803	6N	8F	P141	6C	9K	R614	3H	7E	U475A	3D	4J
C805	7S	7F				R615	4M	9B	U475B	3D	4J
C806	7P	7F	Q600	4L	4J	R617	3M	5G	U475C	1D	4J
C808	5P	7F	Q623	1P	6G	R618	3L	5G	U475D	3E	4J
C809	5S	7F	Q624	1N	6G	R619	3P	6G	U475E	3E	4J
C817	3B	7E				R622	4N	6G	U485A	2C	3K
C822	5B	8F	R401	2F	5F	R624	1P	6G	U485B	2D	3K
C956	8M	6K	R402	3F	5F	R638	3N	6J	U485C	1B	3K
C957	8M	7J	R403	2K	5J	R639	4N	6J	U485D	1C	3K
C972	9S	9K	R412	2F	4F	R642	4L	3E	U485E	1B	3K
C995	9B	7K	R416	2F	4F	R650	4K	4J	U600	2P	6H
			R470	4C	3K	R659	3N	6J	U735A	5K	7E
CR476	3E	3J	R471	3C	4K	R731	5K	7E	U735B	5K	7E
CR484	4C	3K	R476	3F	4J	R732	6J	7E	U735C	6K	7E
CR485	4C	3K	R477	3E	3J	R733	6K	7E	U735D	6J	7E
CR495	2D	3K	R478	3E	3J	R734	6K	7E	U735E	6K	7E
CR600	4L	6J	R479	2E	4J	R735	6K	7E	U800	5P	7F
CR616	4H	6K	R480	2D	2J	R800	7M	8F	U850A	8M	8F
CR956	8N	7K	R481	3D	4K	R801	7M	8F	U860C	7L	6F
CR966	8S	9K	R482	3D	4K	R802	6N	8F	U950	8P	8K
CR972	9S	9K	R483	2C	4K	R803	6N	8G	U975A	4D	6K
			R484	3D	4K	R804	6S	7F	U975C	7H	6K
DL100	2H	5K	R485	4C	4K	R805	6P	7F	U980B	8H	6K
			R486	2C	4K	R806	7S	7F	U980C	7H	6K
J191	8S	8K	R487	2B	3K	R809	5S	7F			
J411	10S	1K	R488	2B	3K	R817	2B	6F	W106	9B	7K
J411	2B	1K	R489	2B	3K	R820	6L	6E	W141	7F	9K
J511	4B	1D	R490	1C	3J	R821	6L	6E	W141	9C	9K
J512	10B	1H	R491	1D	3J	R822	5B	6E	W916	2S	7H
J512	9S	1H	R492	2E	3J	R823	6M	8E	W917	3S	7H
			R493	2D	3J	R850	6L	8F	W918	5S	7G
			R494	2D	3K	R855	6N	6F	W919	6S	7G
L605	2N	5H	R495	2F	4J	R856	6M	9E			
L606	2M	5J	R496	2F	4J	R858	6M	9E			
L607	2M	5G	R497	4C	5K	R858	6M	9E			
L608	2N	5H	R498	3D	6K	R860	6M	9D			

Partial A1 also shown on diagrams 4, 5, 8 and 11.

ASSEMBLY A9

CIRCUIT NUMBER	SCHEM LOCATION	BOARD LOCATION	CIRCUIT NUMBER	SCHEM LOCATION	BOARD LOCATION	CIRCUIT NUMBER	SCHEM LOCATION	BOARD LOCATION	CIRCUIT NUMBER	SCHEM LOCATION	BOARD LOCATION
P191	9L	4B	R1820	9K	1B	R1842	9K	1C			
			R1834	9L	1B						

Partial A9 also shown on diagrams 8 and 12.

ASSEMBLY A14

CIRCUIT NUMBER	SCHEM LOCATION	BOARD LOCATION	CIRCUIT NUMBER	SCHEM LOCATION	BOARD LOCATION	CIRCUIT NUMBER	SCHEM LOCATION	BOARD LOCATION	CIRCUIT NUMBER	SCHEM LOCATION	BOARD LOCATION
C3401	9D	2B	R3402	8E	1B	R3408	7F	2B	U3402	7E	2B
J141	5F	2B	R3403	6D	2A	R3409	6E	2B	VR3401	5D	2A
J141	6C	2B	R3404	8F	2B	R3410	8D	3A			
			R3405	7D	2A	R3411	8D	3B			
R3401	8F	1A	R3406	7D	2B	U3401	8E	2B			
			R3407	6F	2A						

CHASSIS MOUNTED PARTS

CIRCUIT NUMBER	SCHEM LOCATION	BOARD LOCATION	CIRCUIT NUMBER	SCHEM LOCATION	BOARD LOCATION	CIRCUIT NUMBER	SCHEM LOCATION	BOARD LOCATION	CIRCUIT NUMBER	SCHEM LOCATION	BOARD LOCATION
J6	9A	CHASSIS									

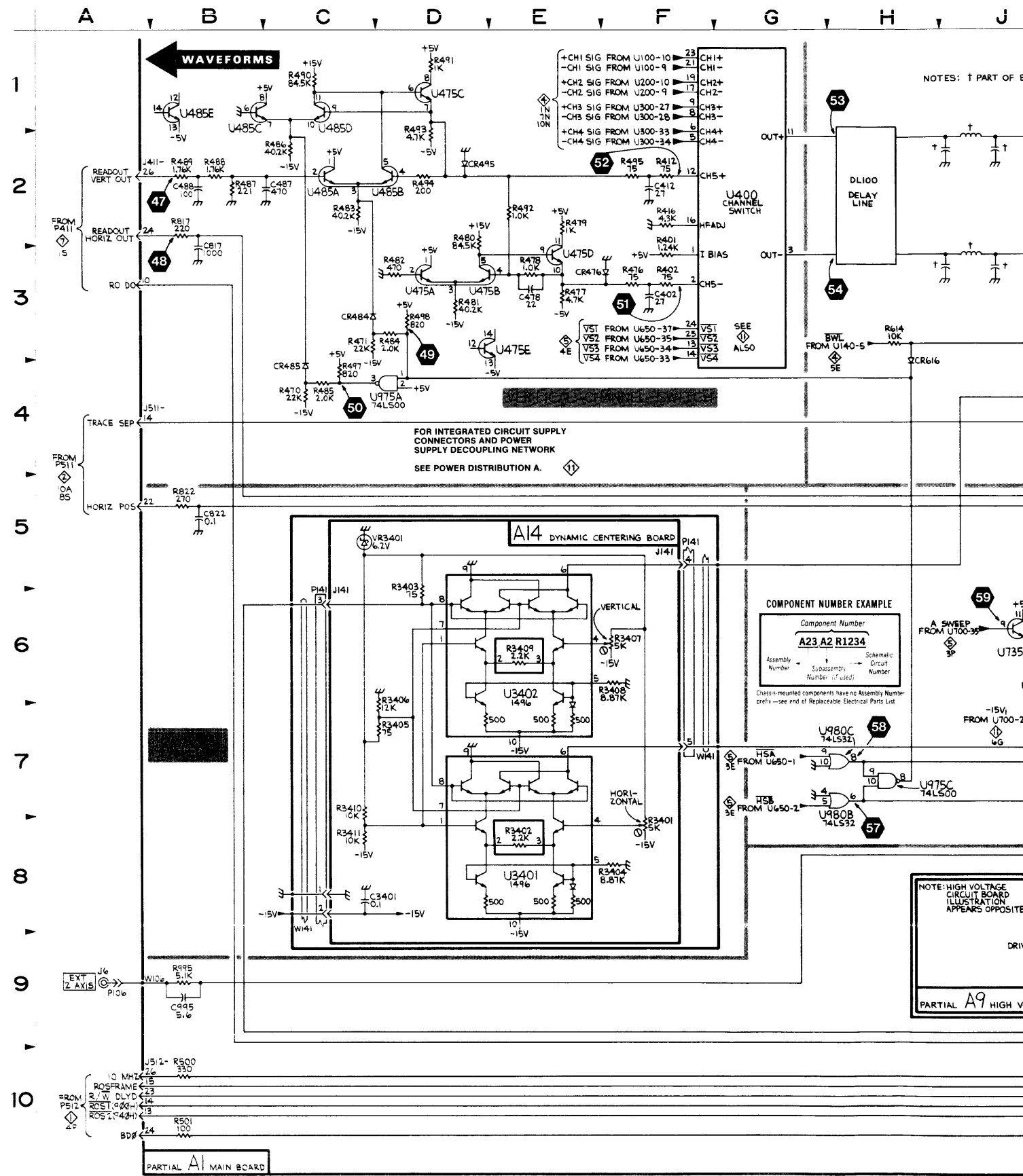

2445

A B C D E F G H J K L M N P S T

1
2
3
4
5
6
7
8
9
10

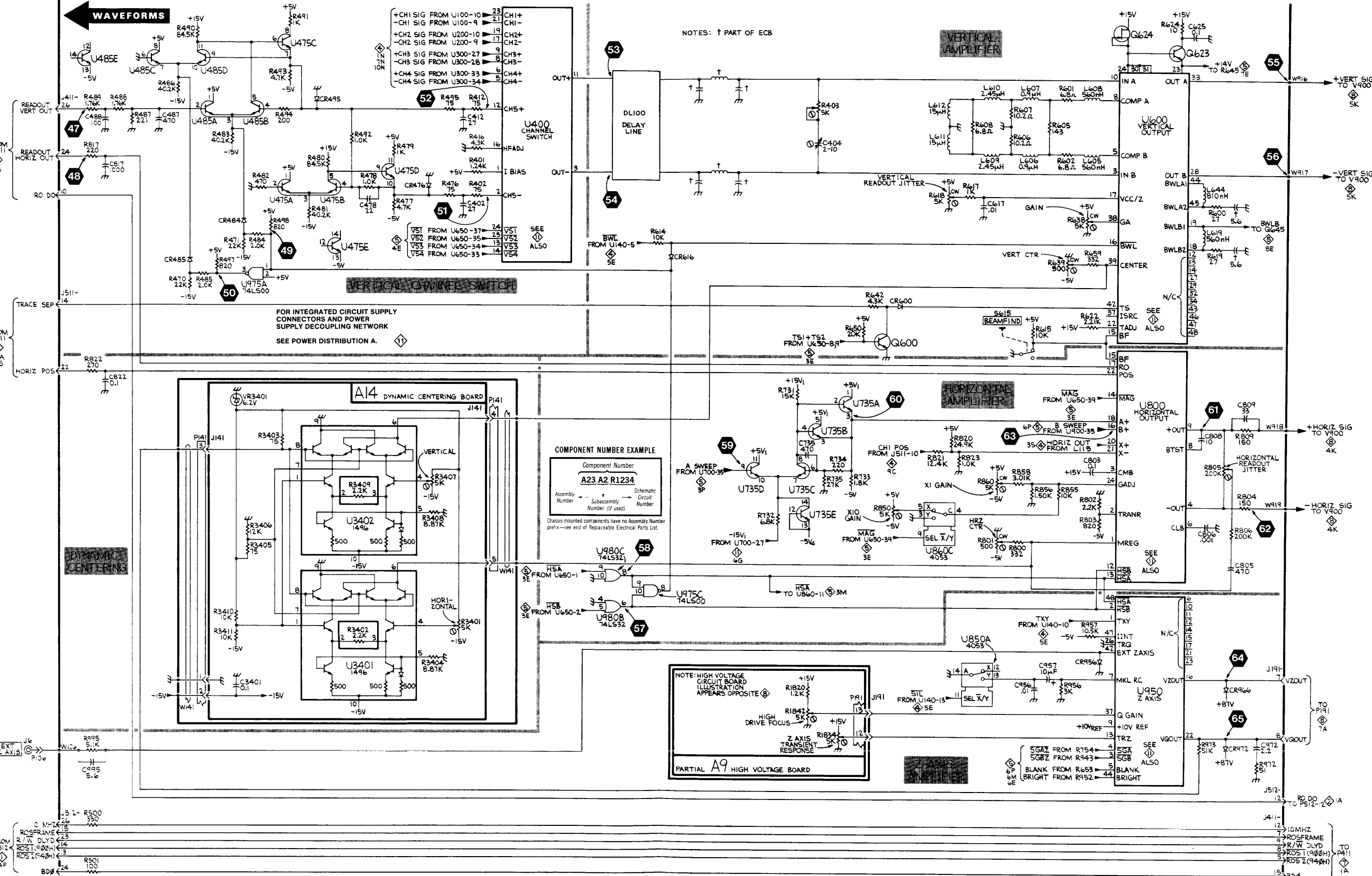

SCHEM LOCATION	BOARD LOCATION
8N	7K
8N	7J
9S	9K
9P	9K
9B	7K
4M	8B
2G	5E
3D	4J
3D	4J
1D	4J
3E	4J
2C	3K
2D	3K
1B	3K
1C	3K
1B	3K
2P	6H
5K	7E
5K	7E
6K	7E
6J	7E
6K	7E
5P	7F
8M	8F
7L	6F
8P	8K
4D	6K
7H	6K
8H	6K
7H	6K
9B	7K
7F	9K
9C	9K
2S	7H
3S	7H
5S	7G
6S	7G

SCHEM LOCATION	BOARD LOCATION

SCHEM LOCATION	BOARD LOCATION
7E	2B
5D	2A

SCHEM LOCATION	BOARD LOCATION

2445

3829-77

CHANNEL SWITCH AND OUTPUT AMPLIFIERS

NUMERAL AND LETTER AT SIGNAL LINES TO OR FROM OTHER DIAGRAMS INDICATES THE GRID COORDINATES ON ANOTHER SCHEMATIC (FOR EXAMPLE: 4E)
 Static Sensitive Devices
 See Maintenance Section
 NOTE: † PART OF ECB

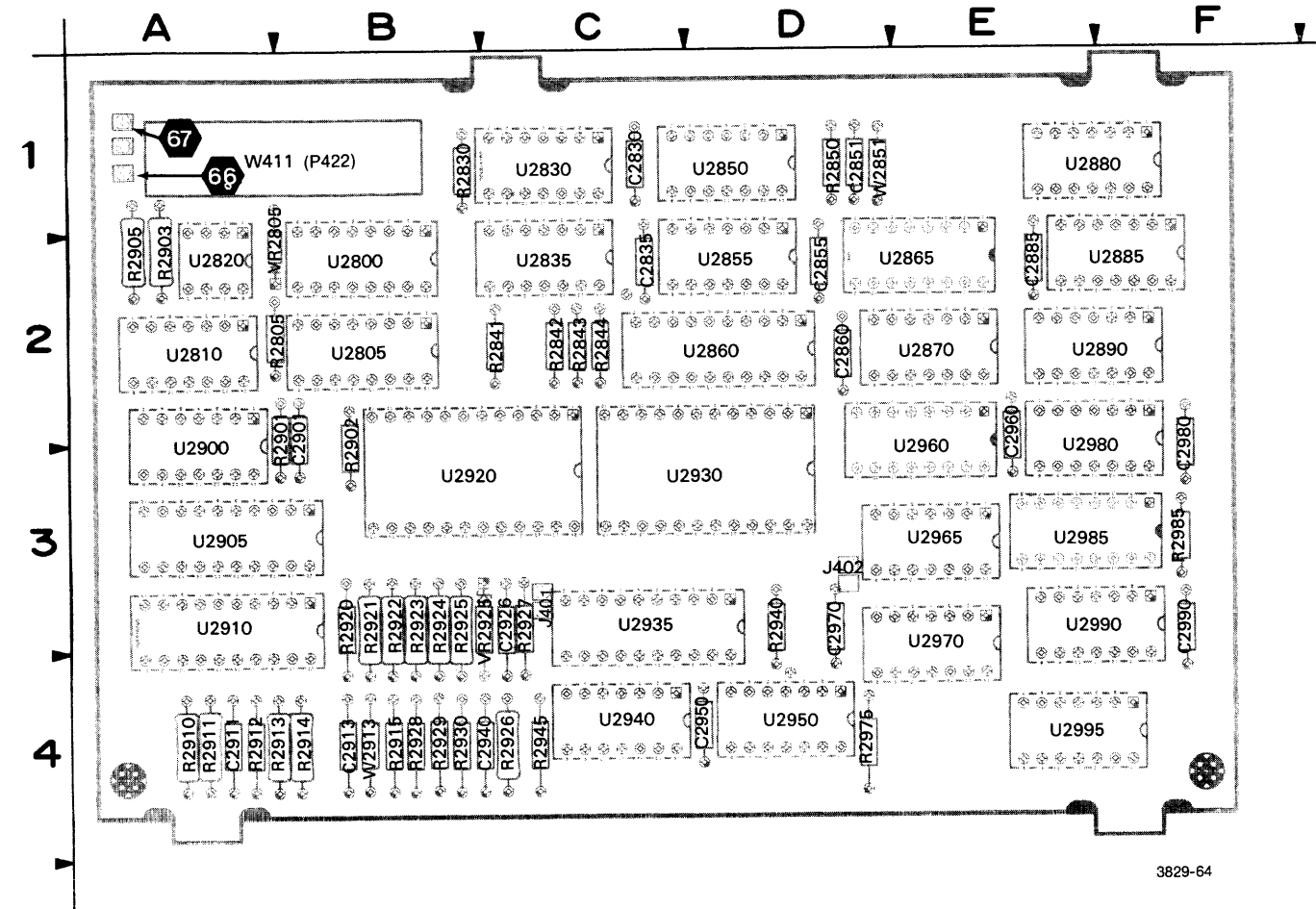

3829-64

Figure 9-10. A4—Readout board.

() COMPONENTS WITHIN PARENTHESES MAY NOT BE LOCATED PRECISELY AS SHOWN BUT ARE NEAR THEIR INDICATED POSITION.

⊗ Static Sensitive Devices
See Maintenance Section

COMPONENT NUMBER EXAMPLE

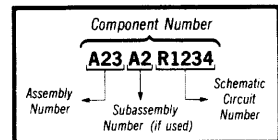

Chassis-mounted components have no Assembly Number prefix—see end of Replaceable Electrical Parts List.

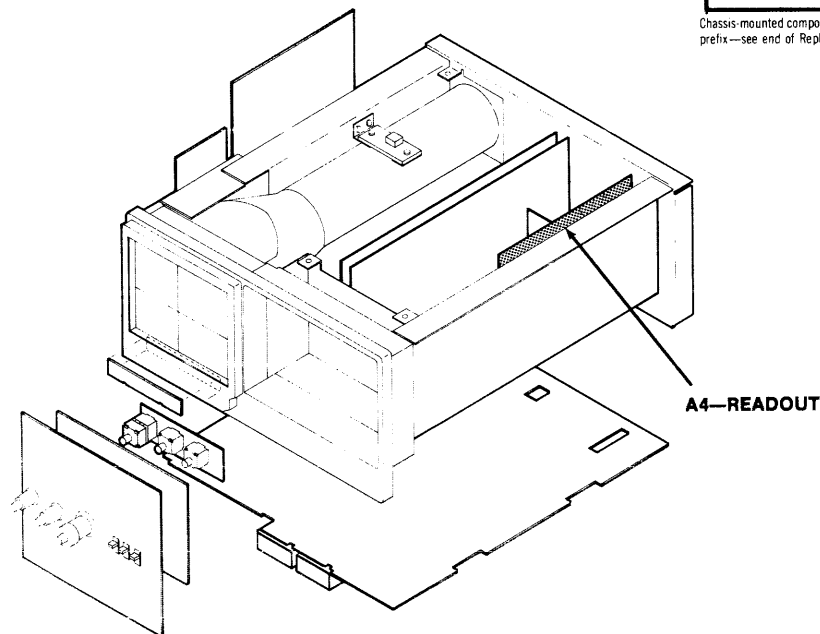

A4—READOUT BOARD

CIRCUIT NUMBER	SCHEM NUMBER	CIRCUIT NUMBER	SCHEM NUMBER	CIRCUIT NUMBER	SCHEM NUMBER	CIRCUIT NUMBER	SCHEM NUMBER
C2830	12	R2920	7	U2855	7	U2940	12
C2835	12	R2921	7	U2855	7	U2950	7
C2851	12	R2922	7	U2855	7	U2950	7
C2855	12	R2923	7	U2855	12	U2950	12
C2860	12	R2924	7	U2860	7	U2960	7
C2885	12	R2925	7	U2860	12	U2960	12
C2901	12	R2926	7	U2865	7	U2965	7
C2911	7	R2927	7	U2865	12	U2965	7
C2913	12	R2928	7	U2870	7	U2965	7
C2926	12	R2929	7	U2870	7	U2965	7
C2940	12	R2930	7	U2870	12	U2965	12
C2950	12	R2940	7	U2880	7	U2970	7
C2960	12	R2945	7	U2880	7	U2970	7
C2970	12	R2975	7	U2880	12	U2970	7
C2980	12	R2985	7	U2885	7	U2970	7
C2990	12	U2800	7	U2885	7	U2970	12
J401	7	U2800	12	U2885	7	U2980	7
J402	7	U2805	7	U2885	12	U2980	7
P411	7	U2805	12	U2890	7	U2980	7
P411	7	U2810	7	U2890	7	U2980	7
P411	7	U2810	7	U2890	7	U2980	12
P411	12	U2810	7	U2890	7	U2985	7
R2805	12	U2810	7	U2890	12	U2985	12
R2830	7	U2810	12	U2900	7	U2990	7
R2841	7	U2820	7	U2900	7	U2990	7
R2842	7	U2820	7	U2900	7	U2990	7
R2843	7	U2820	12	U2900	12	U2990	7
R2844	7	U2830	7	U2905	7	U2990	12
R2850	7	U2830	7	U2905	12	U2995	7
R2901	7	U2830	12	U2910	7	U2995	12
R2902	7	U2835	7	U2910	12	VR2805	12
R2903	7	U2835	7	U2920	7	VR2925	7
R2905	7	U2835	7	U2920	12	W411	7
R2910	7	U2835	7	U2930	7	W411	7
R2911	7	U2835	12	U2930	12	W411	7
R2912	7	U2850	7	U2935	7	W411	12
R2913	7	U2850	7	U2935	12	W2851	12
R2914	7	U2850	12	U2940	7	W2913	12
R2915	7	U2855	7	U2940	7		

The numbered waveforms board dolly. The waveforms setup conditions are observed

TEST WAVEFORM SETUP INFORMATION

The numbered waveforms below were obtained at the test points indicated on the accompanying schematic diagram and board dolly. The waveforms are representative of signals that may be expected at the associated points when the indicated setup conditions are observed.

A4—READOUT BOARD

CIRCUIT NUMBER	SCHEM NUMBER	CIRCUIT NUMBER	SCHEM NUMBER	CIRCUIT NUMBER	SCHEM NUMBER	CIRCUIT NUMBER	SCHEM NUMBER
C2830	12	R2920	7	U2855	7	U2940	12
C2835	12	R2921	7	U2855	7	U2950	7
C2851	12	R2922	7	U2855	7	U2950	7
C2855	12	R2923	7	U2855	12	U2950	12
C2860	12	R2924	7	U2860	7	U2960	7
C2885	12	R2925	7	U2860	12	U2960	12
C2901	12	R2926	7	U2865	7	U2965	7
C2911	7	R2927	7	U2865	12	U2965	7
C2913	12	R2928	7	U2870	7	U2965	7
C2926	12	R2929	7	U2870	7	U2965	7
C2940	12	R2930	7	U2870	12	U2965	12
C2950	12	R2940	7	U2880	7	U2970	7
C2960	12	R2945	7	U2880	7	U2970	7
C2970	12	R2975	7	U2880	12	U2970	7
C2980	12	R2985	7	U2885	7	U2970	7
C2990	12	U2800	7	U2885	7	U2970	12
J401	7	U2800	12	U2885	7	U2980	7
J402	7	U2805	7	U2885	12	U2980	7
P411	7	U2805	12	U2890	7	U2980	7
P411	7	U2810	7	U2890	7	U2980	7
P411	7	U2810	7	U2890	7	U2980	12
P411	12	U2810	7	U2890	7	U2985	7
R2805	12	U2810	7	U2890	12	U2985	12
R2830	7	U2810	12	U2900	7	U2990	7
R2841	7	U2820	7	U2900	7	U2990	7
R2842	7	U2820	7	U2900	7	U2990	7
R2843	7	U2820	12	U2900	12	U2990	7
R2844	7	U2830	7	U2905	7	U2990	12
R2850	7	U2830	7	U2905	12	U2995	7
R2901	7	U2830	12	U2910	7	U2995	12
R2902	7	U2835	7	U2910	12	VR2805	12
R2903	7	U2835	7	U2920	7	VR2925	7
R2905	7	U2835	7	U2920	12	W411	7
R2910	7	U2835	7	U2930	7	W411	7
R2911	7	U2835	12	U2930	12	W411	7
R2912	7	U2850	7	U2935	7	W411	12
R2913	7	U2850	7	U2935	12	W2851	12
R2914	7	U2850	12	U2940	7	W2913	12
R2915	7	U2855	7	U2940	7		

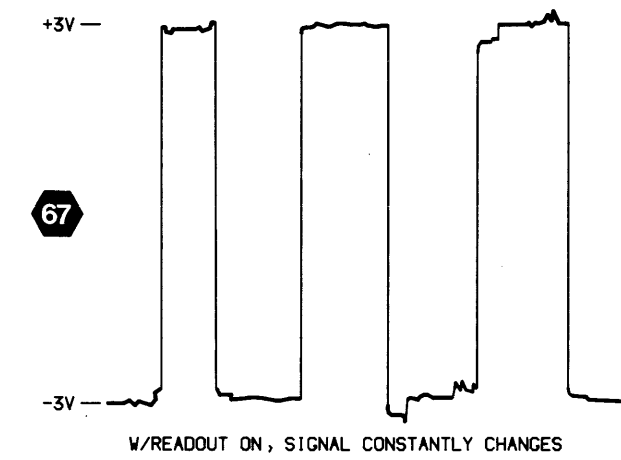
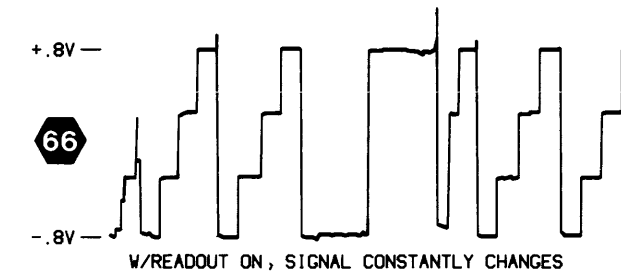

3829-55

READOUT DIAGRAM

7

ASSEMBLY A4

CIRCUIT NUMBER	SCHEM LOCATION	BOARD LOCATION	CIRCUIT NUMBER	SCHEM LOCATION	BOARD LOCATION	CIRCUIT NUMBER	SCHEM LOCATION	BOARD LOCATION
C2911	2K	4A	R2945	2B	4C	U2900B	5L	2A
J401	1H	3C	R2975	7M	4D	U2900B	9L	2A
J402	3H	3D	R2985	8E	3F	U2900C	5L	2A
						U2905	4K	3A
						U2910	1K	3A
P411	1A	1A	U2800	4P	2B	U2920	2F	3B
P411	1S	1A	U2805	2P	2B	U2930	1H	3D
P411	9S	1A	U2810A	6L	2A	U2935	1D	3C
			U2810B	6L	2A	U2940A	2C	4C
			U2810C	6N	2A	U2940B	1B	4C
R2830	8C	1B	U2810D	5N	2A	U2950A	9E	4D
R2841	5M	2C	U2820A	5P	2A	U2950B	9J	4D
R2842	3B	2C	U2820B	3P	2A	U2960	3D	2E
R2843	4B	2C	U2830A	8C	1C	U2965A	5C	3E
R2844	5B	2C	U2830B	7B	1C	U2965B	9H	3E
R2850	9D	1D	U2835A	6G	2C	U2965C	4F	3E
R2901	5M	2B	U2835B	9K	2C	U2965D	9M	3E
R2902	3F	2B	U2835C	9G	2C	U2970A	9N	3E
R2903	5P	2A	U2835D	2E	2C	U2970B	9H	3E
R2905	5P	2A	U2850A	9D	1D	U2970C	7G	3E
R2910	1K	4A	U2850B	9E	1D	U2970D	9G	3E
R2911	1K	4A	U2855A	7B	2D	U2980A	9H	2E
R2912	2L	4A	U2855B	6E	2D	U2980B	8P	2E
R2913	3L	4A	U2855C	3E	2D	U2980C	9N	2E
R2914	3L	4B	U2855D	3E	2D	U2980D	5E	2E
R2915	4L	4B	U2860	5F	2D	U2985	8F	3E
R2920	4M	3B	U2865	6D	2E	U2990A	8E	3E
R2921	5M	3B	U2870A	6F	2E	U2990B	9H	3E
R2922	5M	3B	U2870B	5F	2E	U2990C	9M	3E
R2923	4M	3B	U2880A	8J	1E	U2990D	8M	3E
R2924	4M	3B	U2880B	8P	1E	U2995	9M	4E
R2925	4M	3B	U2885A	10H	2F			
R2926	5M	4C	U2885B	8J	2F	VR2925	4M	3C
R2927	2H	3C	U2885C	8S	2F			
R2928	4L	4B	U2890A	8B	2E			
R2929	4L	4B	U2890B	9K	2E	W411	10S	1A
R2930	4M	4B	U2890C	8L	2E	W411	1A	1A
R2940	8D	3D	U2890D	9K	2E	W411	5S	1A

Partial A4 also shown on diagram 12.

ACRONYM DICTIONARY

The following listing explains some of the less obvious acronyms and signal labels used on this schematic. Acronyms and labels not shown in this listing may be included in the circuit descriptions (Section 3) and should be obvious if a little thought is given to the intended circuit function.

BD0 ... buffered data bit 0

CA0 - CA6 ... character address bits 0 - 7

CD0 - CD7 ... character data bits 0 - 7

DD0 - DD7 ... dot data bits 0 - 7

EOCH ... end of character

EOCH1 ... end of character delayed 1 dot

EOCH2 ... end of character delayed 2 dots

RA0 - RA6 ... RAM address bits 0 - 6

ROA ... readout acknowledge

ROB ... readout blank

RO DO ... readout data out

ROR ... readout request

ROR DOT TIMER DELAY ... readout request dot timer delay

ROSFAME ... readout subframe

ROS1 ... readout strobe 1

ROS2 ... readout strobe 2

R/W DLYD ... read/write delayed

SGA ... sweep gate A

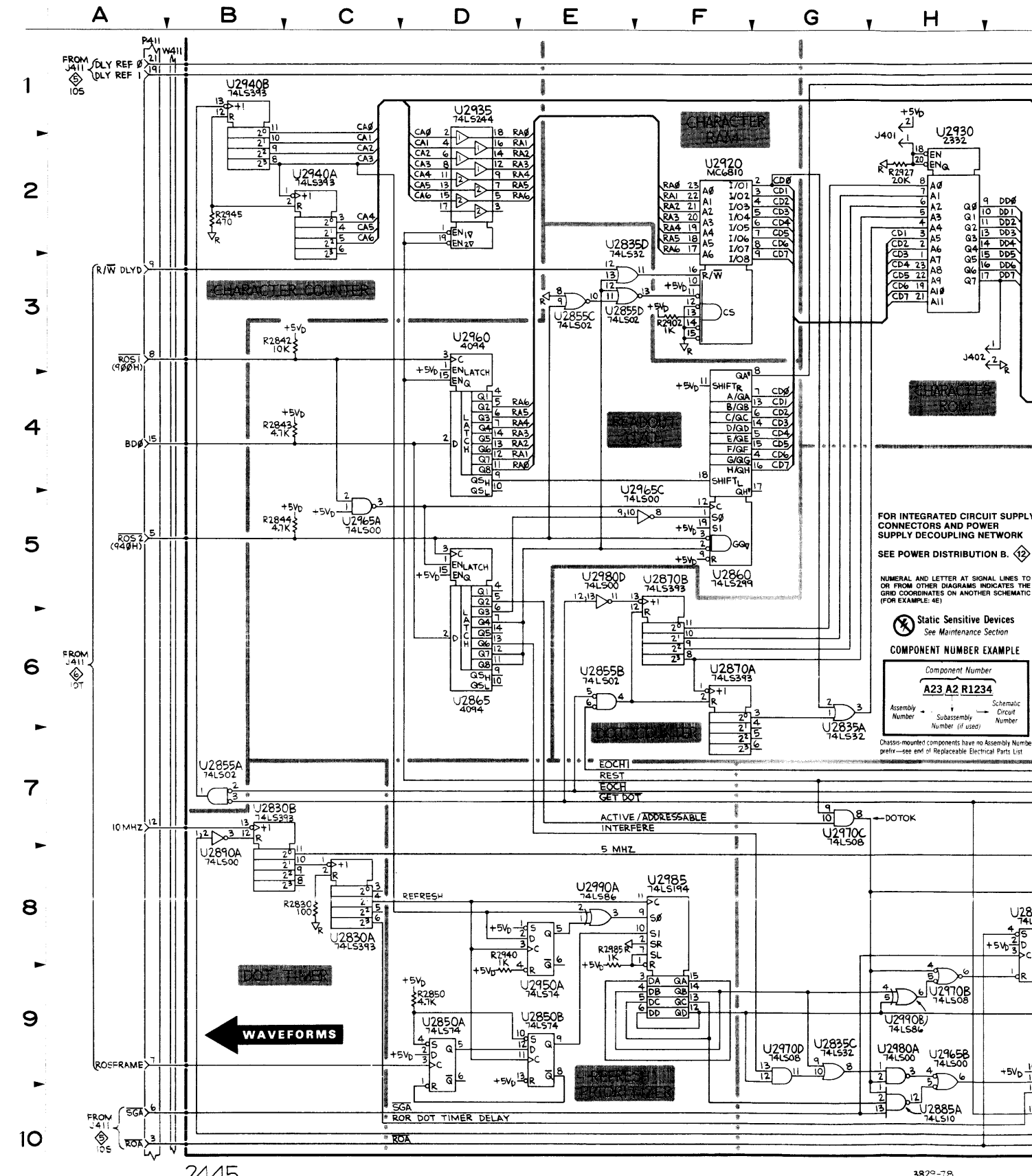

2445

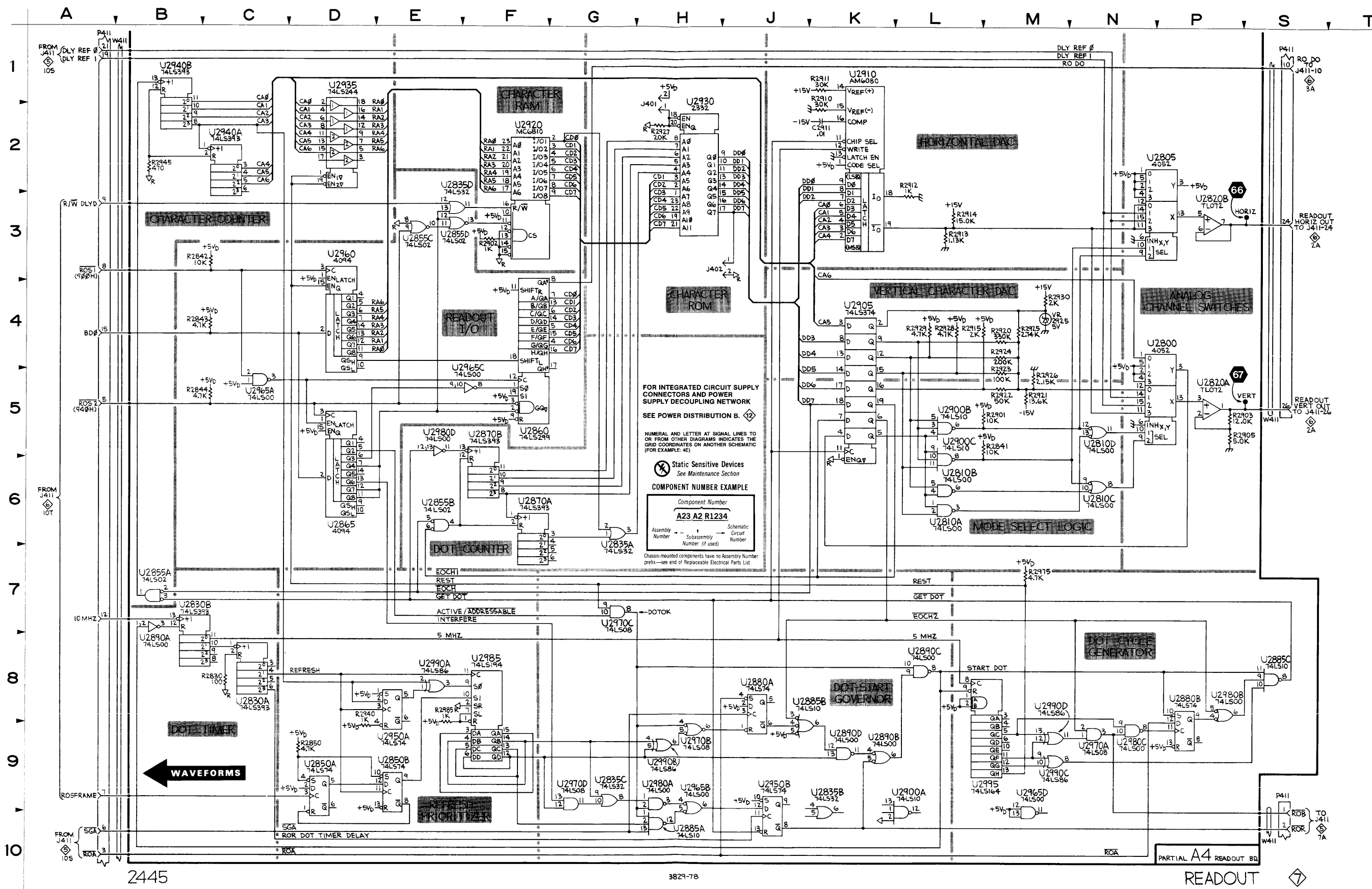

ARD

A
A
A
A
B
C
C
D
D
E
E
E
E
E
E
E
E
E
E
E
E
E
E
C
A
A
A

request dot timer delay

← WAVEFORMS

PARTIAL A4 READOUT BD

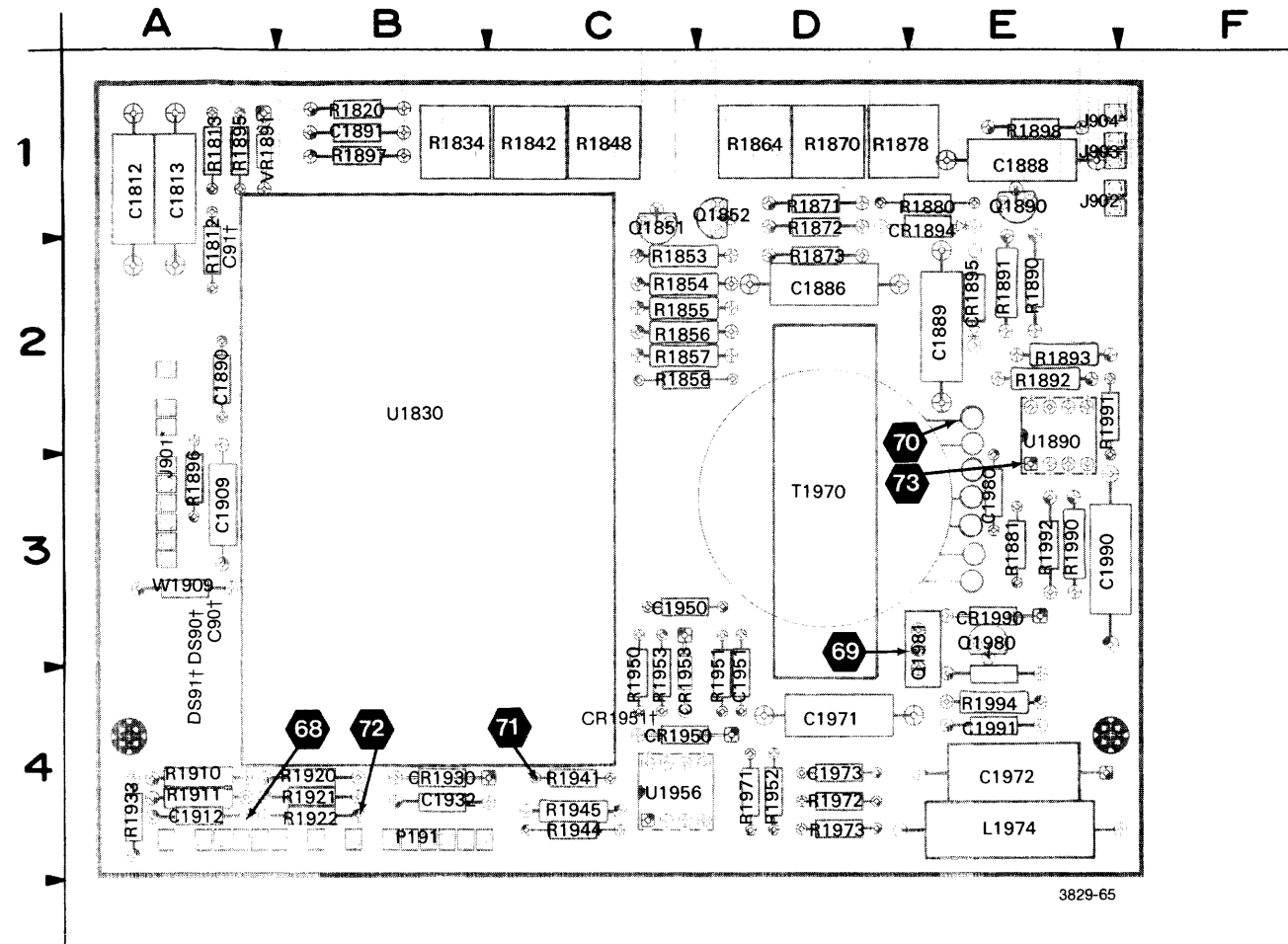
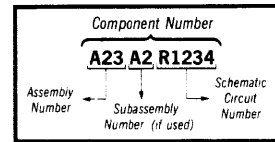

Figure 9-11. A9—High Voltage board.

- * LABELED ON SOME BOARDS AS "P" VICE "J".
- † INDICATES COMPONENTS THAT WERE MANUALLY ADDED TO THE BOARD AS A RESULT OF MODIFICATION.

⊗ Static Sensitive Devices
See Maintenance Section

COMPONENT NUMBER EXAMPLE



Chassis-mounted components have no Assembly Number prefix—see end of Replaceable Electrical Parts List.

ACRONYM DICTIONARY

The following listing explains some of the less obvious acronyms and signal labels used on this schematic. Acronyms and labels not shown in this listing may be included in the circuit descriptions (Section 3) and should be obvious if a little thought is given to the intended circuit function.

- PDA (14KV) . . . post deflection accelerator
- VQOUT . . . variable quadrupole out
- VZOUT . . . variable Z-axis out

A9—HIGH VOLTAGE BOARD

CIRCUIT NUMBER	SCHEM NUMBER	CIRCUIT NUMBER	SCHEM NUMBER	CIRCUIT NUMBER	SCHEM NUMBER
C90	8	L1974	8	R1896	8
C91	8	P191	6	R1897	8
C1812	8	P191	8	R1898	8
C1813	8	P191	8	R1910	8
C1886	8	P191	12	R1911	8
C1888	8	Q1851	8	R1920	8
C1889	8	Q1852	8	R1921	8
C1890	8	Q1890	8	R1922	8
C1891	8	Q1980	8	R1922	8
C1909	12	Q1981	8	R1933	12
C1912	8	R1812	8	R1941	8
C1932	8	R1813	8	R1944	8
C1950	8	R1820	6	R1945	8
C1951	8	R1834	6	R1950	8
C1971	8	R1842	6	R1951	8
C1972	8	R1848	8	R1952	8
C1973	8	R1853	8	R1953	8
C1980	8	R1854	8	R1971	8
C1990	8	R1855	8	R1972	8
C1991	8	R1856	8	R1973	8
CR1894	8	R1857	8	R1990	8
CR1895	8	R1858	8	R1991	8
CR1930	8	R1864	8	R1992	8
CR1950	8	R1870	8	R1994	8
CR1951	8	R1871	8	T1970	8
CR1953	8	R1872	8	U1830	8
CR1990	8	R1873	8	U1890	8
DS90	8	R1878	8	U1890	8
DS91	8	R1880	8	U1890	12
J901	8	R1881	8	U1956	8
J901	8	R1890	8	U1956	8
J901	8	R1891	8	U1956	12
J902	8	R1892	8	VR1891	8
J903	8	R1893	8	W1909	12
J904	8	R1895	8		

The numbered waveform board dolly. The waveform instrument is running.

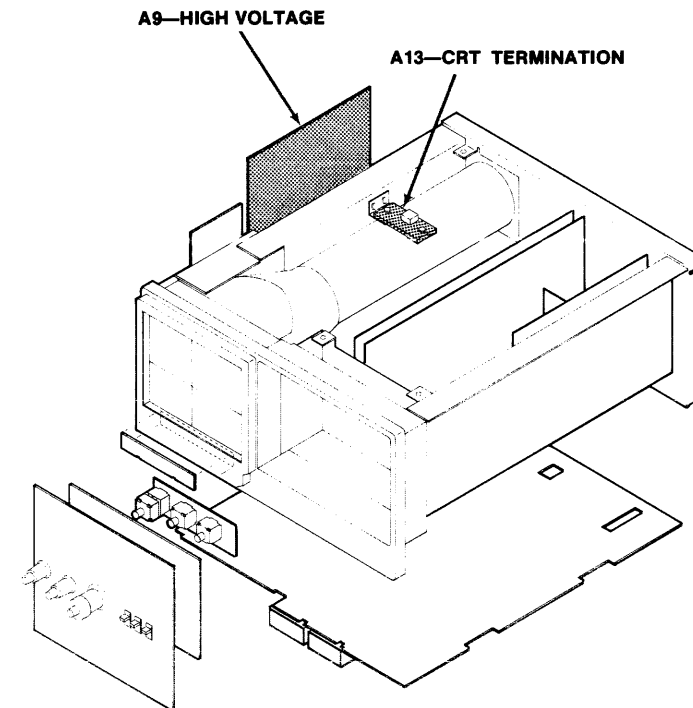

A9—HIGH VOLTAGE BOARD

CIRCUIT NUMBER	SCHEM NUMBER	CIRCUIT NUMBER	SCHEM NUMBER	CIRCUIT NUMBER	SCHEM NUMBER
C90	8	L1974	8	R1896	8
C91	8	P191	6	R1897	8
C1812	8	P191	8	R1898	8
C1813	8	P191	8	R1910	8
C1886	8	P191	12	R1911	8
C1888	8	Q1851	8	R1920	8
C1889	8	Q1852	8	R1921	8
C1890	8	Q1890	8	R1922	8
C1891	8	Q1980	8	R1922	8
C1909	12	Q1981	8	R1933	12
C1912	8	R1812	8	R1941	8
C1932	8	R1813	8	R1944	8
C1950	8	R1820	6	R1945	8
C1951	8	R1834	6	R1950	8
C1971	8	R1842	6	R1951	8
C1972	8	R1848	8	R1952	8
C1973	8	R1853	8	R1953	8
C1980	8	R1854	8	R1971	8
C1990	8	R1855	8	R1972	8
C1991	8	R1856	8	R1973	8
CR1894	8	R1857	8	R1990	8
CR1895	8	R1858	8	R1991	8
CR1930	8	R1864	8	R1992	8
CR1950	8	R1870	8	R1994	8
CR1951	8	R1871	8	T1970	8
CR1953	8	R1872	8	U1830	8
CR1990	8	R1873	8	U1890	8
DS90	8	R1878	8	U1890	8
DS91	8	R1880	8	U1890	12
J901	8	R1881	8	U1956	8
J901	8	R1890	8	U1956	8
J901	8	R1891	8	U1956	12
J902	8	R1892	8	VR1891	8
J903	8	R1893	8	W1909	12
J904	8	R1895	8		

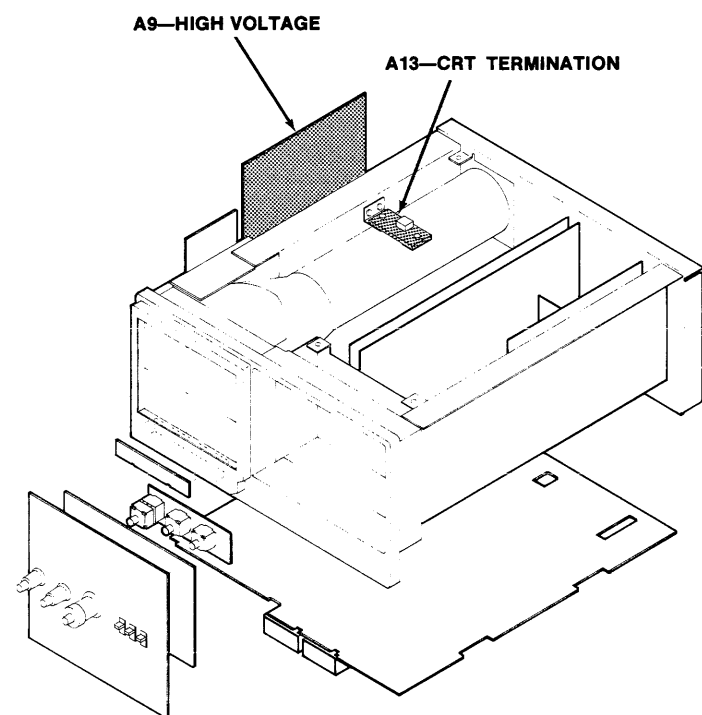

TEST WAVEFORM SETUP INFORMATION

The numbered waveforms below were obtained at the test points indicated on the accompanying schematic diagram and board dolly. The waveforms are representative of signals that may be expected at the associated points whenever the instrument is running.

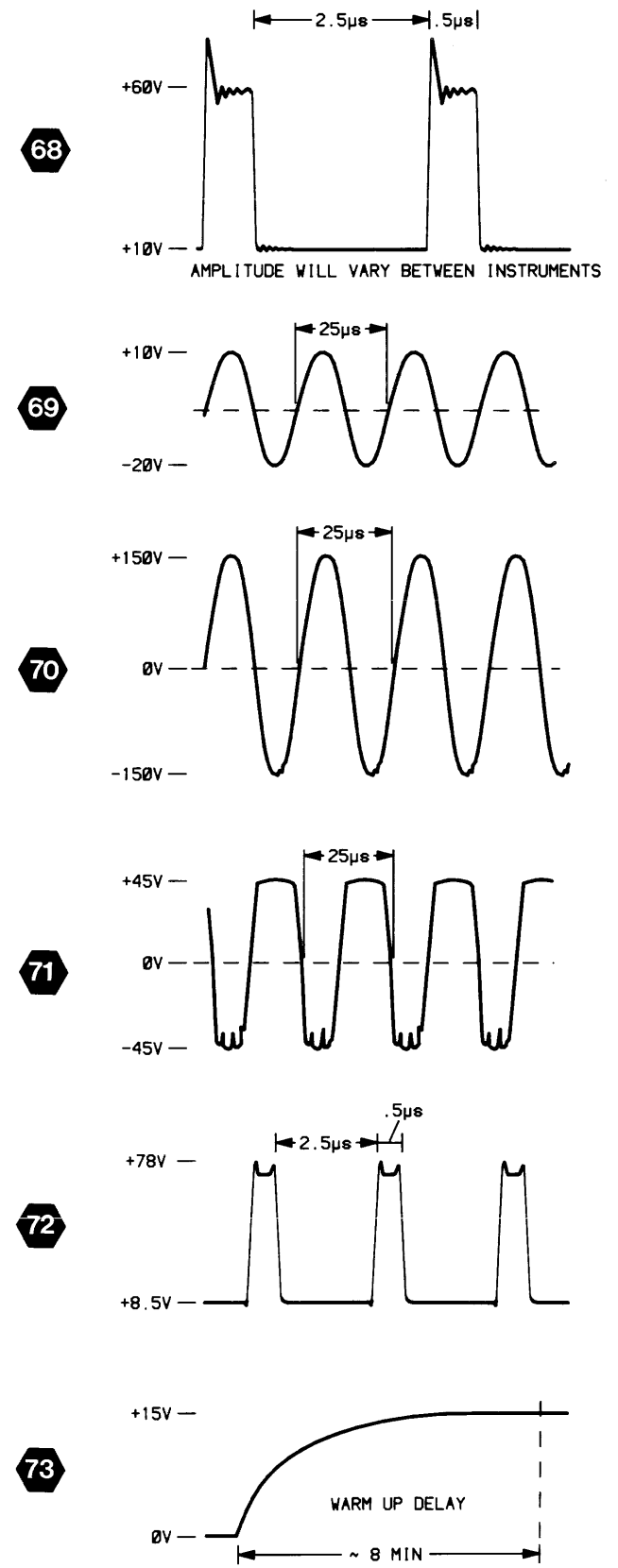

Devices Section
EXAMPLE
 4
 Schematic - Circuit Number
 Assembly Number
 Mechanical Parts List.

HIGH VOLTAGE SUPPLY AND CRT DIAGRAM

8

ASSEMBLY A1											
CIRCUIT NUMBER	SCHEM LOCATION	BOARD LOCATION	CIRCUIT NUMBER	SCHEM LOCATION	BOARD LOCATION	CIRCUIT NUMBER	SCHEM LOCATION	BOARD LOCATION	CIRCUIT NUMBER	SCHEM LOCATION	BOARD LOCATION
C975	3D	7B	J112	3C	7B	J115	4C	8B			
			J114	2C	8B						

Partial A1 also shown on diagrams 4, 5, 6 and 11.

ASSEMBLY A9											
CIRCUIT NUMBER	SCHEM LOCATION	BOARD LOCATION	CIRCUIT NUMBER	SCHEM LOCATION	BOARD LOCATION	CIRCUIT NUMBER	SCHEM LOCATION	BOARD LOCATION	CIRCUIT NUMBER	SCHEM LOCATION	BOARD LOCATION
C90	9H	3A	CR1990	8E	3E	R1853	4F	2C	R1922	7E	4B
C91	8H	2A				R1854	5F	2C	R1941	7E	4C
C1812	4F	1A	DS90	7H	3A	R1855	4E	2C	R1944	6C	4C
C1813	5F	1A	DS91	8H	4A	R1856	4E	2C	R1945	6D	4C
C1886	8C	2D				R1857	5E	2C	R1950	7C	4C
C1888	3H	1E	J901	3M	3A	R1858	5E	2C	R1951	7A	4D
C1889	8B	2E	J901	4J	3A	R1864	3F	1D	R1952	6B	4D
C1890	5S	2A	J901	5M	3A	R1870	3N	1D	R1953	7C	4C
C1891	3G	1B	J902	2J	1E	R1871	4F	1D	R1971	6B	4D
C1912	6N	4A	J903	4M	1E	R1872	5F	1D	R1972	6C	4D
C1932	6D	4B	J904	5P	1E	R1873	3F	2D	R1973	6C	4D
C1950	7B	3C				R1878	8D	1D	R1990	3G	3E
C1951	7B	4D	L1974	9A	4E	R1880	4H	1E	R1991	8D	2E
C1971	8E	4D				R1881	8E	3E	R1992	8E	3E
C1972	8A	4E	P191	2E	4B	R1890	3G	2E	R1994	8E	4E
C1973	6C	4D	P191	7A	4B	R1891	4G	2E			
C1980	8B	3E				R1892	3G	2E	T1970	10B	3D
C1990	8D	3E	Q1851	4F	1C	R1893	3G	2E			
C1991	7E	4E	Q1852	5F	1D	R1895	5S	1A	U1830	8G	2B
			Q1890	3H	1E	R1896	5S	3A	U1890A	8D	2E
CR1894	8C	1E	Q1980	8E	3E	R1897	3H	1B	U1890B	3G	2E
CR1895	8B	2E	Q1981	8B	3E	R1898	4N	1E	U1956A	6C	4C
CR1930	7E	4B				R1910	6P	4A	U1956B	6B	4C
CR1950	7E	4C	R1812	4F	2A	R1911	6P	4A			
CR1951	7E	4C	R1813	5F	1A	R1920	7E	4B	VR1891	5S	1A
CR1953	7C	4C	R1848	4N	1C	R1921	6P	4B			

Partial A9 also shown on diagrams 6 and 12.

ASSEMBLY A13											
CIRCUIT NUMBER	SCHEM LOCATION	BOARD LOCATION	CIRCUIT NUMBER	SCHEM LOCATION	BOARD LOCATION	CIRCUIT NUMBER	SCHEM LOCATION	BOARD LOCATION	CIRCUIT NUMBER	SCHEM LOCATION	BOARD LOCATION
J904	5P	**	R1501	5N	**						

CHASSIS MOUNTED PARTS											
CIRCUIT NUMBER	SCHEM LOCATION	BOARD LOCATION	CIRCUIT NUMBER	SCHEM LOCATION	BOARD LOCATION	CIRCUIT NUMBER	SCHEM LOCATION	BOARD LOCATION	CIRCUIT NUMBER	SCHEM LOCATION	BOARD LOCATION
L90	2L	CHASSIS	P901	3M	CHASSIS	R976	5B	CHASSIS	W115	5B	CHASSIS
LR1513	5M	CHASSIS	P901	4J	CHASSIS	R977	4B	CHASSIS	W900	3M	CHASSIS
LR1514	5M	CHASSIS	P901	5M	CHASSIS	R996	3K	CHASSIS	W900	6J	CHASSIS
			P902	2J	CHASSIS				W900	7J	CHASSIS
			P903	4M	CHASSIS	V900	2L	CHASSIS	W900	7M	CHASSIS
			P904	5P	CHASSIS				W902	3J	CHASSIS
P112	3C	CHASSIS				W112	4B	CHASSIS	W903	4M	CHASSIS
P114	2C	CHASSIS				W114	3B	CHASSIS	W904	5P	CHASSIS
P115	4C	CHASSIS	R975	2B	CHASSIS						

★★ BOARD ILLUSTRATION NOT SHOWN

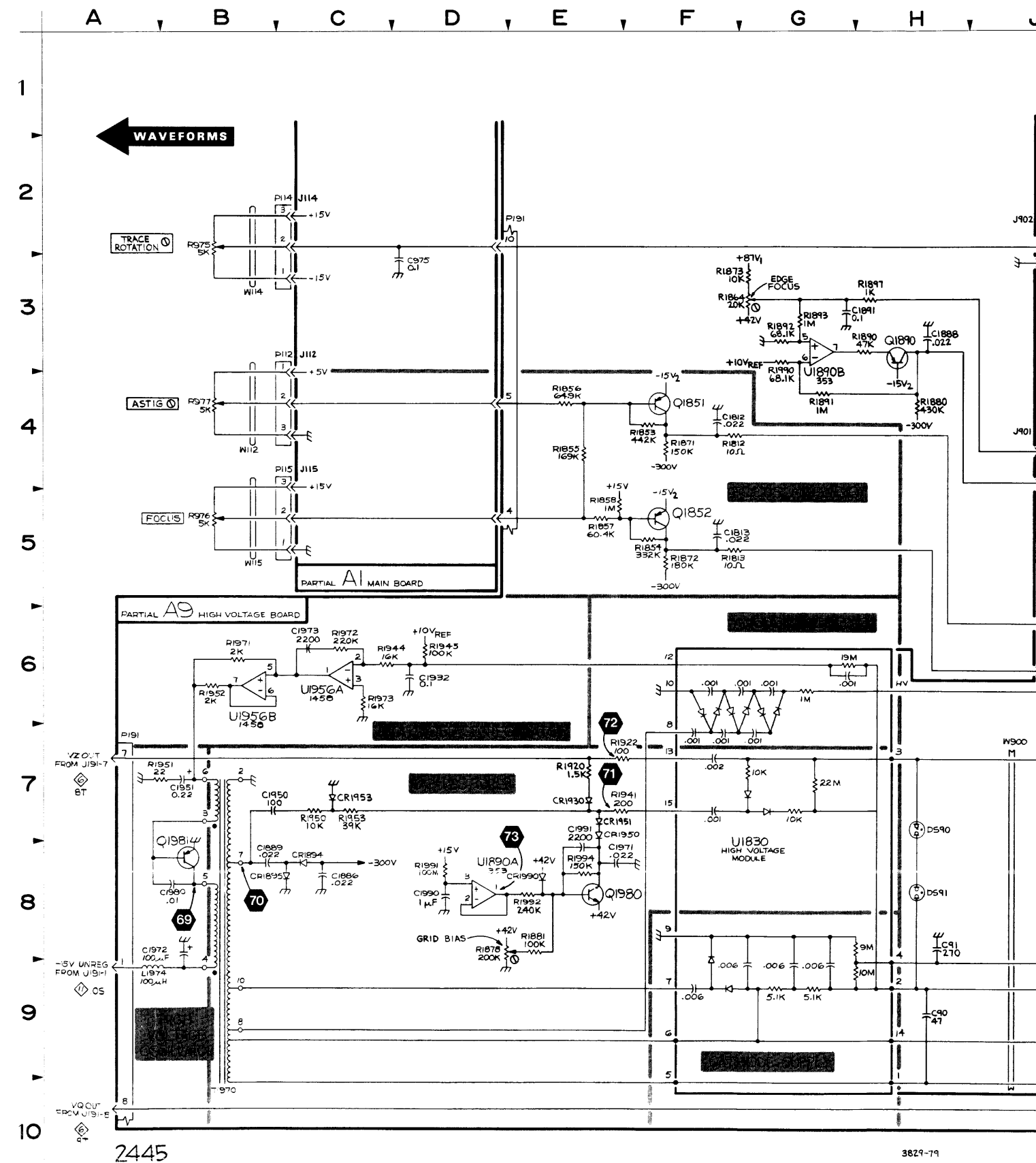

SCHEM LOCATION	BOARD LOCATION

SCHEM LOCATION	BOARD LOCATION
7E	4B
7E	4C
6C	4C
6D	4C
7C	4C
7A	4D
6B	4D
7C	4C
6B	4D
6C	4D
3G	3E
8D	2E
8E	3E
8E	4E
10B	3D
8G	2B
8D	2E
3G	2E
6C	4C
6B	4C
5S	1A

SCHEM LOCATION	BOARD LOCATION

SCHEM LOCATION	BOARD LOCATION
5B	CHASSIS
3M	CHASSIS
6J	CHASSIS
7J	CHASSIS
7M	CHASSIS
3J	CHASSIS
4M	CHASSIS
5P	CHASSIS

IN NOT SHOWN

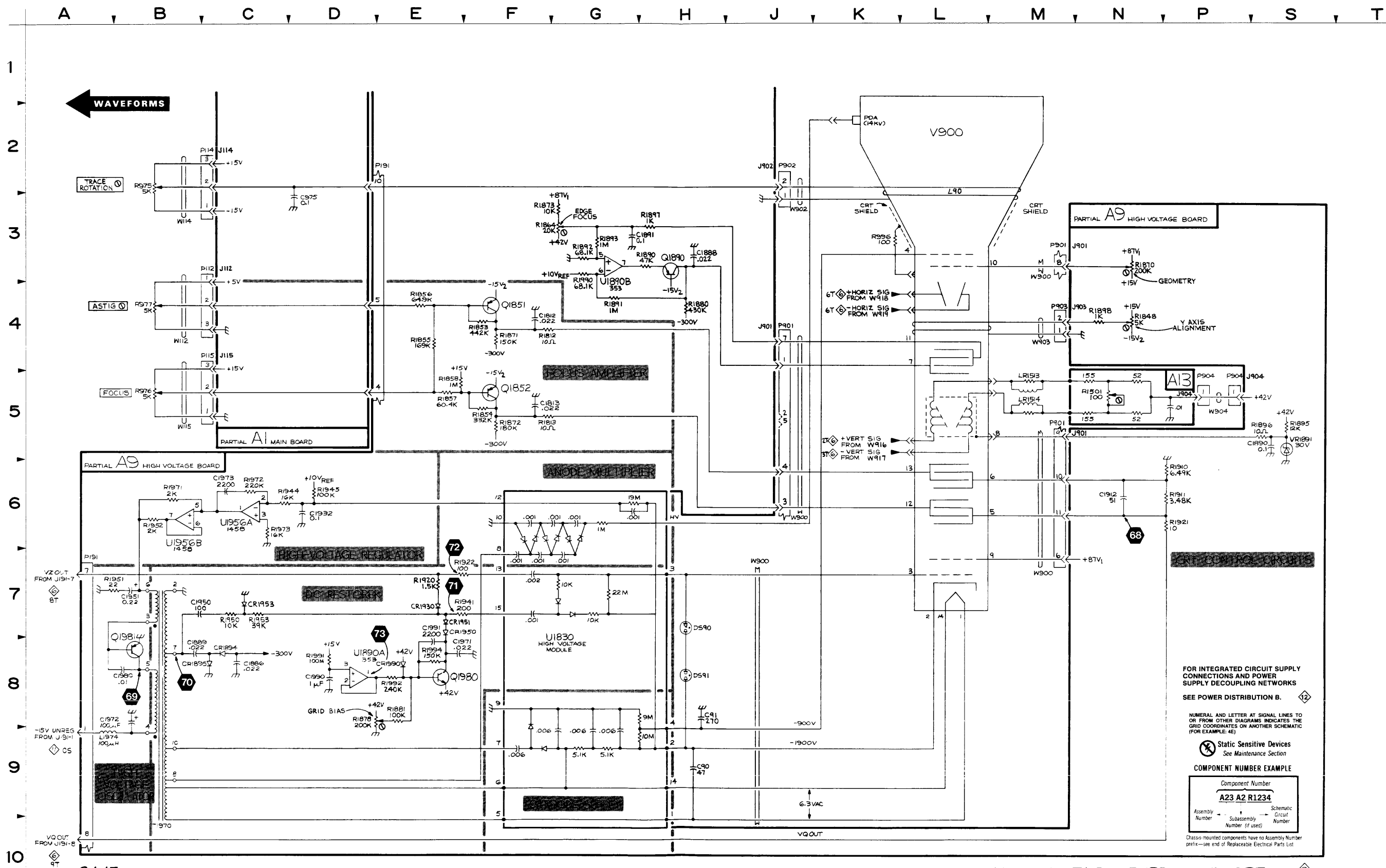

2445

3829-79

HIGH-VOLTAGE SUPPLY AND CRT

FOR INTEGRATED CIRCUIT SUPPLY CONNECTIONS AND POWER SUPPLY DECOUPLING NETWORKS
SEE POWER DISTRIBUTION B.

NUMERAL AND LETTER AT SIGNAL LINES TO OR FROM OTHER DIAGRAMS INDICATES THE GRID COORDINATES ON ANOTHER SCHEMATIC (FOR EXAMPLE: 4E).

Static Sensitive Devices
See Maintenance Section

COMPONENT NUMBER EXAMPLE

Component Number
A23 A2 R1234
Assembly Number Subassembly Number (if used) Schematic Circuit Number

Chassis-mounted components have no Assembly Number prefix—see end of Replaceable Electrical Parts List

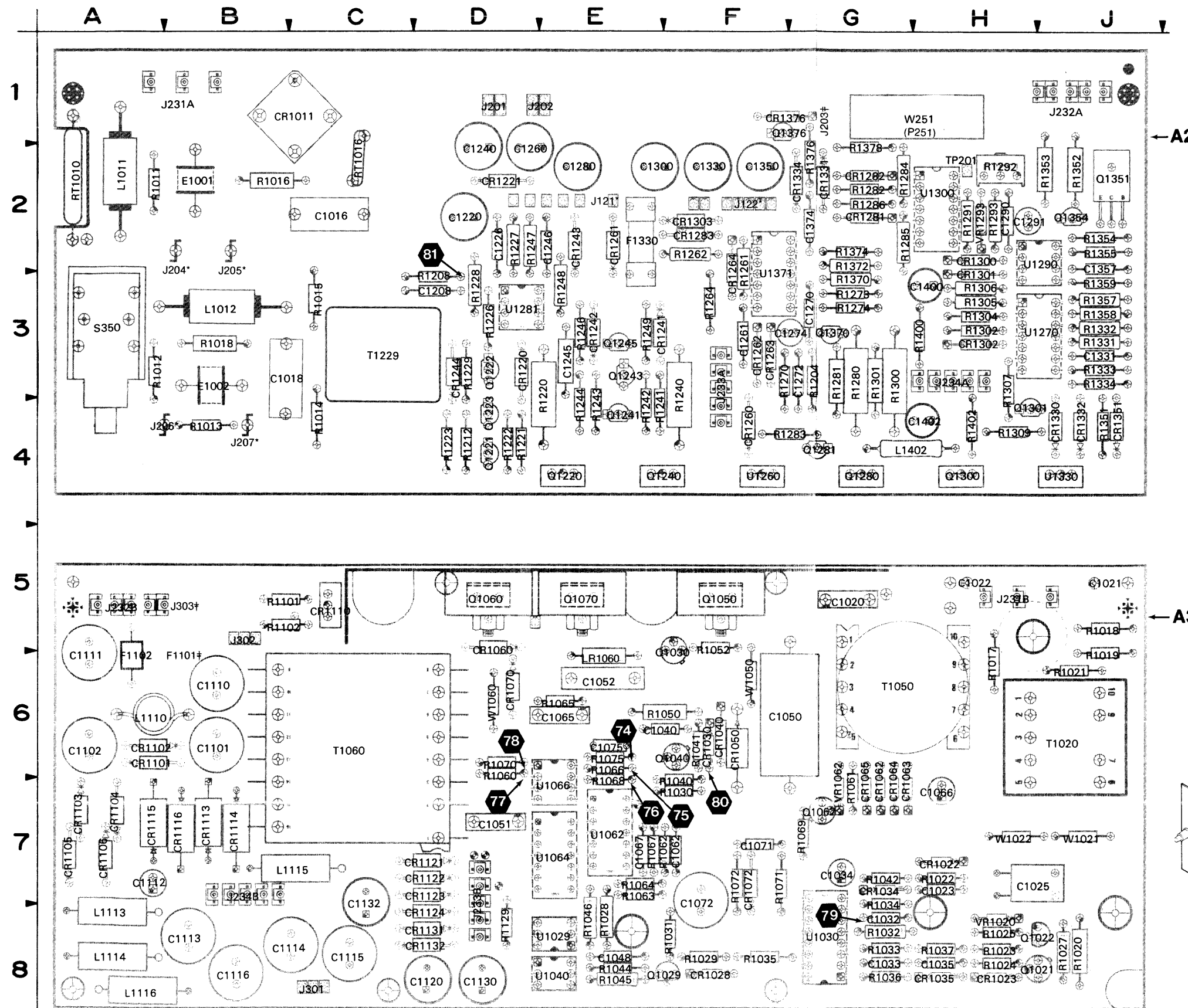

* LABELED ON SOME BOARDS AS "P" VICE "J".

‡ THESE COMPONENTS MAY NOT EXIST IN EARLIER INSTRUMENTS.

() COMPONENTS WITHIN PARENTHESES MAY NOT BE LOCATED PRECISELY AS SHOWN BUT ARE NEAR THEIR INDICATED POSITION.

ALL COMPONENTS MOUNTED ON A3—INVERTER BOARD ARE SHOWN ON SCHEMATIC

DIAGRAM 9

The numbered waveforms board dolly. The waveforms instrument is running.

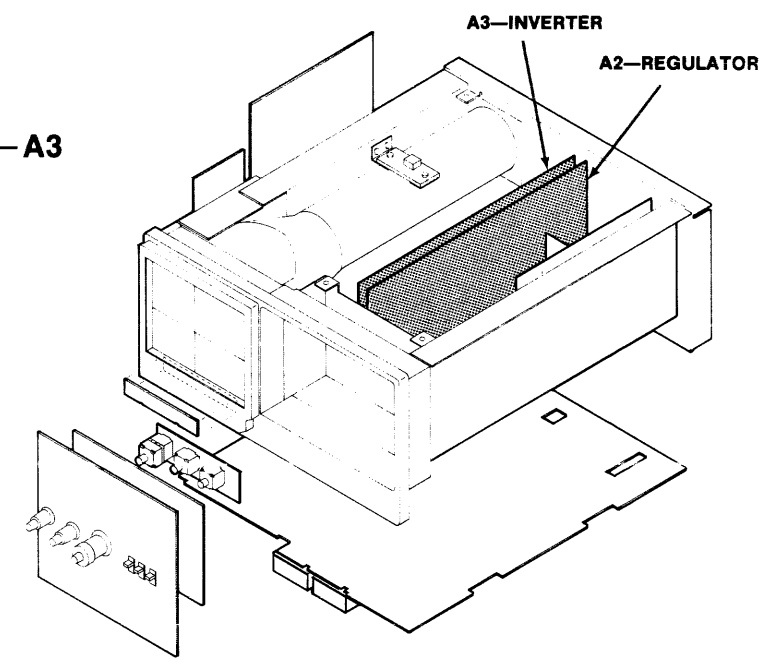
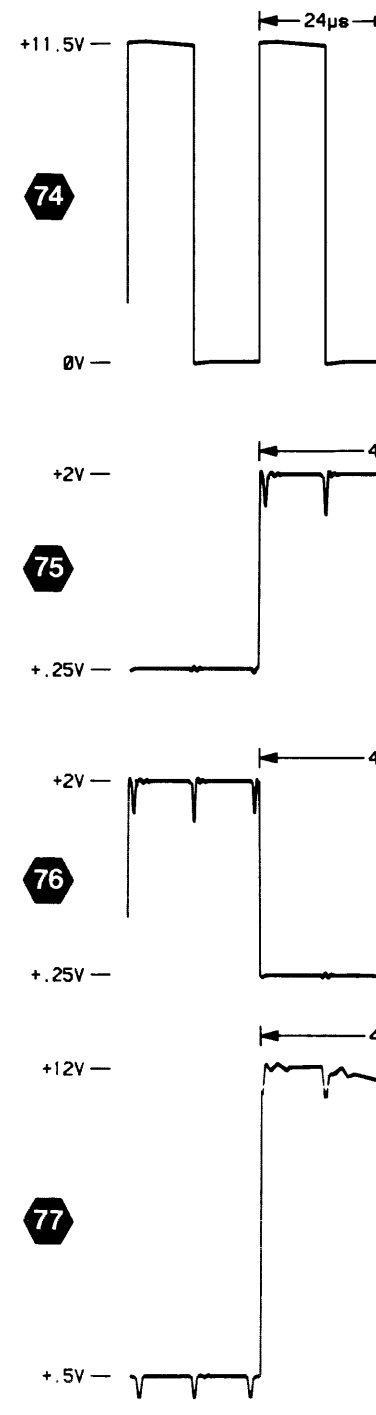

⚡ Static Sensitive Devices
See Maintenance Section

COMPONENT NUMBER EXAMPLE

Component Number		
A23 A2 R1234		
Assembly Number	Subassembly Number (if used)	Schematic Circuit Number

Chassis-mounted components have no Assembly Number prefix—see end of Replaceable Electrical Parts List.

Figure 9-12. A2—Regulator and A3—Inverter boards.

TEST WAVEFORM SETUP INFORMATION

The numbered waveforms below were obtained at the test points indicated on the accompanying schematic diagram and board dolly. The waveforms are representative of signals that may be expected at the associated points whenever the instrument is running.

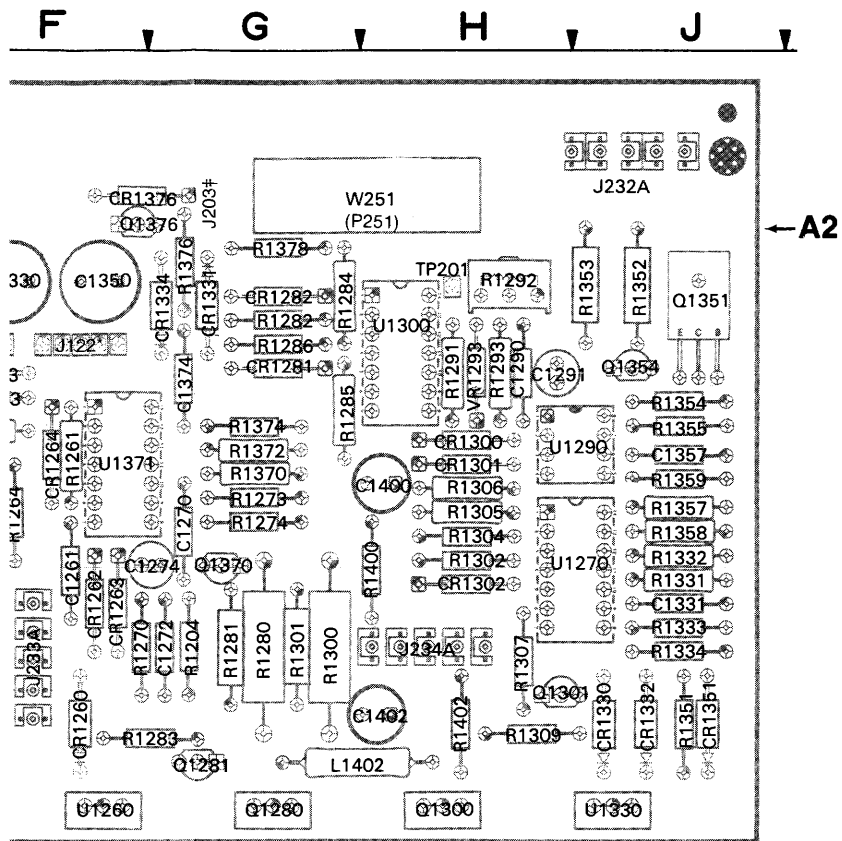

- * LABELED ON SOME BOARDS AS "P" VICE "J".
- ‡ THESE COMPONENTS MAY NOT EXIST IN EARLIER INSTRUMENTS.
- () COMPONENTS WITHIN PARENTHESES MAY NOT BE LOCATED PRECISELY AS SHOWN BUT ARE NEAR THEIR INDICATED POSITION.

ALL COMPONENTS MOUNTED ON A3—INVERTER BOARD ARE SHOWN ON SCHEMATIC DIAGRAM 9

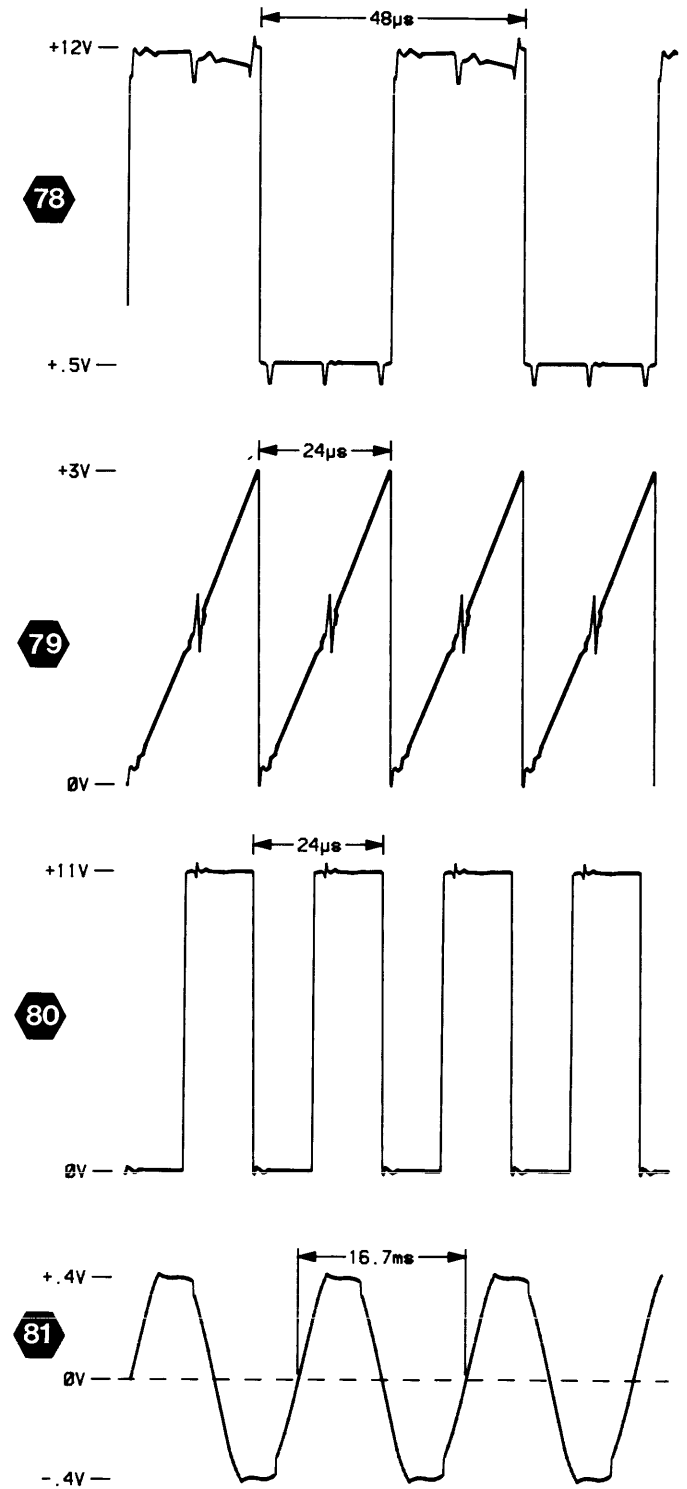
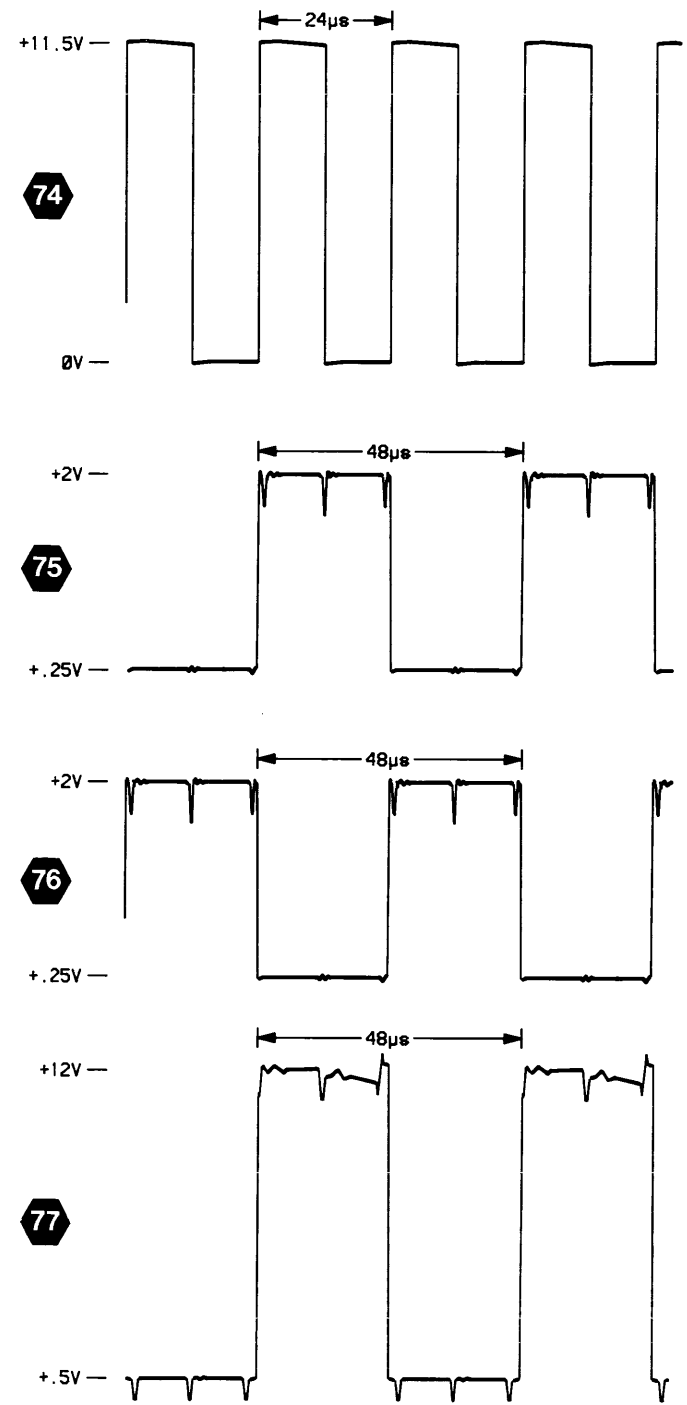
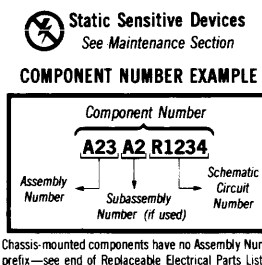
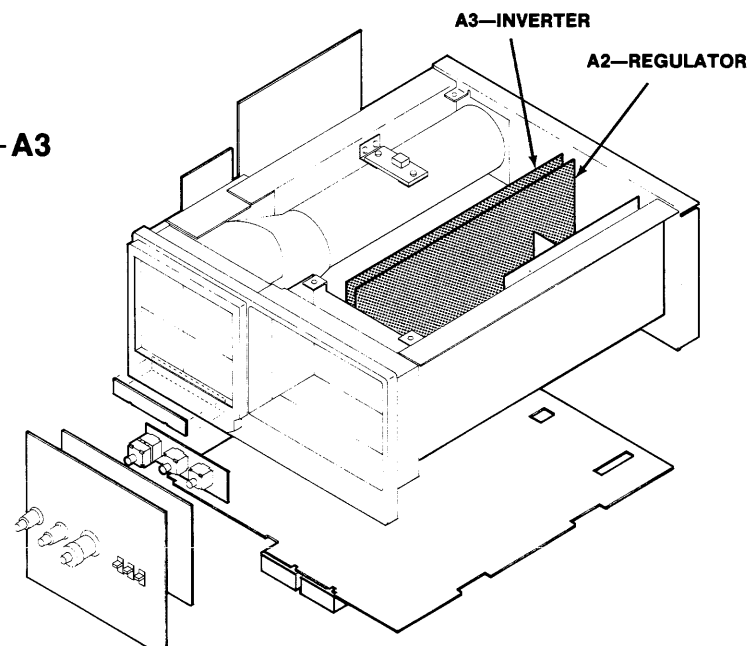
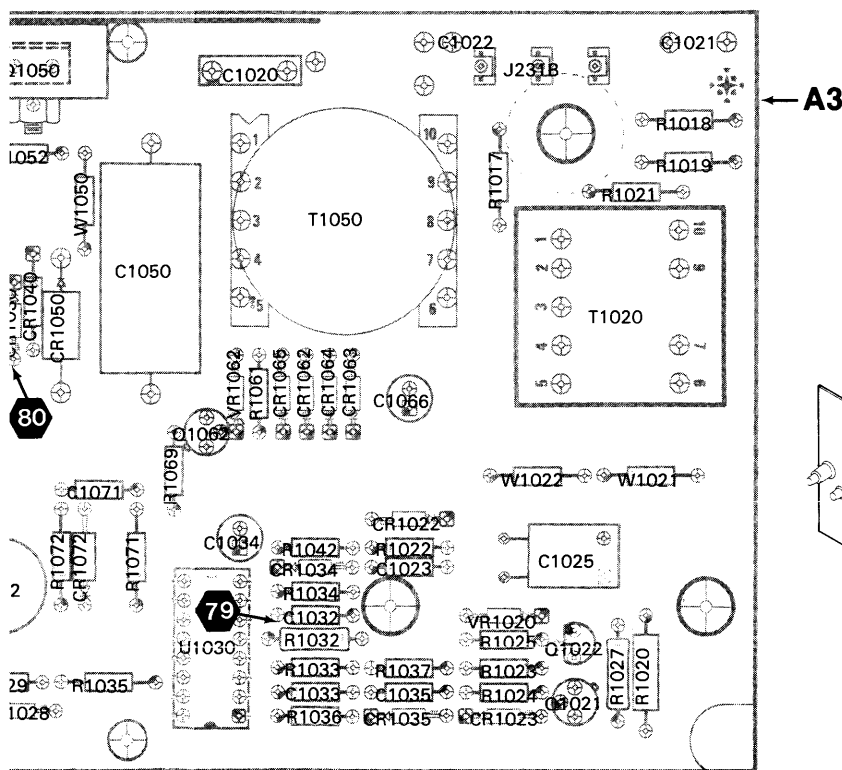

A2—REGULATOR BOARD

CIRCUIT NUMBER	SCHEM NUMBER	CIRCUIT NUMBER	SCHEM NUMBER	CIRCUIT NUMBER	SCHEM NUMBER	CIRCUIT NUMBER	SCHEM NUMBER
C1016	9	CR1351	10	R1015	9	R1331	10
C1018	9	CR1376	10	R1016	9	R1332	10
C1208	9	E1001	9	R1018	9	R1333	10
C1220	10	E1002	9	R1204	10	R1334	10
C1226	10	F1330	10	R1208	9	R1351	10
C1240	10	J121	10	R1212	10	R1352	10
C1245	10	J122	9	R1220	10	R1353	10
C1246	10	J122	10	R1221	10	R1354	10
C1260	10	J201	10	R1222	10	R1355	10
C1261	10	J202	10	R1223	10	R1357	10
C1270	10	J203	10	R1226	10	R1358	10
C1272	10	J204	9	R1227	10	R1359	10
C1274	10	J205	9	R1228	10	R1370	10
C1280	10	J206	9	R1229	10	R1372	10
C1290	10	J207	9	R1240	10	R1374	10
C1291	10	J231	9	R1241	10	R1376	10
C1300	10	J232	10	R1242	10	R1378	10
C1330	10	J232	10	R1243	10	R1400	10
C1331	10	J233	10	R1244	10	R1402	10
C1350	10	J233	10	R1246	10	RT1010	9
C1357	10	J234	10	R1247	10	RT1016	9
C1374	10	J234	10	R1248	10	S350	9
C1400	10	J234	10	R1249	10	T1229	9
C1402	10	L1011	9	R1261	10	TP201	10
CR1011	9	L1012	9	R1262	10	U1260	10
CR1220	10	L1402	10	R1264	10	U1270	10
CR1221	10	P251	10	R1270	10	U1270	10
CR1241	10	Q1220	10	R1273	10	U1270	10
CR1242	10	Q1221	10	R1274	10	U1270	10
CR1243	10	Q1222	10	R1280	10	U1270	10
CR1244	10	Q1223	10	R1281	10	U1281	10
CR1260	10	Q1240	10	R1282	10	U1281	10
CR1261	10	Q1241	10	R1283	10	U1281	10
CR1262	10	Q1243	10	R1284	10	U1290	10
CR1263	10	Q1245	10	R1285	10	U1300	10
CR1264	10	Q1280	10	R1286	10	U1300	10
CR1281	10	Q1281	10	R1291	10	U1300	10
CR1282	10	Q1300	10	R1292	10	U1300	10
CR1283	10	Q1301	10	R1293	10	U1300	10
CR1300	10	Q1351	10	R1300	10	U1330	10
CR1301	10	Q1354	10	R1301	10	U1371	10
CR1302	10	Q1370	10	R1302	10	U1371	10
CR1303	10	Q1376	10	R1304	10	U1371	10
CR1330	10	R1011	9	R1305	10	U1371	10
CR1331	10	R1012	9	R1306	10	U1371	10
CR1332	10	R1013	9	R1307	10	VR1293	10
CR1334	10	R1014	9	R1309	10	W251	10

ACRONYM DICTIONARY

The following listing explains some of the less obvious acronyms and signal labels used on this schematic. Acronyms and labels not shown in this listing may be included in the circuit descriptions (Section 3) and should be obvious if a little thought is given to the intended circuit function.

FB . . . feedback

PWM COMPARATOR . . . pulse-width modulator comparator

+5VD . . . +5 V digital

LOW-VOLTAGE POWER SUPPLY DIAGRAM

9

ASSEMBLY A2											
CIRCUIT NUMBER	SCHEM LOCATION	BOARD LOCATION	CIRCUIT NUMBER	SCHEM LOCATION	BOARD LOCATION	CIRCUIT NUMBER	SCHEM LOCATION	BOARD LOCATION	CIRCUIT NUMBER	SCHEM LOCATION	BOARD LOCATION
C1016	6C	2C	J122	1S	2F	R1011	5B	2A	RT1010	5B	2A
C1018	6B	3B	J204	5B	2B	R1012	6B	3A	RT1016	6C	2C
C1208	1P	3D	J205	6B	2B	R1013	7B	4B			
			J206	6B	4B	R1014	1N	4C	S350	4B	3A
CR1011	5C	1B	J207	7B	4B	R1015	1N	3C			
			J231A	5D	1B	R1016	6C	2B	T1229	1N	3C
E1001	6B	2B	L1011	5B	2A	R1018	6B	3B			
E1002	6C	3B	L1012	6B	3B	R1208	1N	3D			

Partial A2 also shown on diagram 10.

ASSEMBLY A3											
CIRCUIT NUMBER	SCHEM LOCATION	BOARD LOCATION	CIRCUIT NUMBER	SCHEM LOCATION	BOARD LOCATION	CIRCUIT NUMBER	SCHEM LOCATION	BOARD LOCATION	CIRCUIT NUMBER	SCHEM LOCATION	BOARD LOCATION
C1020	4E	5G	CR1060	5L	5D	Q1021	2G	8J	R1064	9E	7E
C1021	7D	5J	CR1062	7F	7G	Q1022	3G	8J	R1065	6L	6E
C1022	6D	5H	CR1063	7F	7G	Q1029	3P	8F	R1066	8J	6E
C1023	3F	7H	CR1064	7F	7G	Q1030	6H	6F	R1067	9E	7E
C1025	3F	7H	CR1065	7F	7G	Q1040	6J	6F	R1068	9J	6E
C1032	3L	8G	CR1070	7L	6D	Q1050	5G	5F	R1069	7G	7G
C1033	4L	8G	CR1072	6G	7F	Q1060	9K	5D	R1070	9K	6D
C1034	3L	7G	CR1101	10M	6A	Q1062	7G	7G	R1071	6H	7F
C1035	4L	8H	CR1102	10M	6A	Q1070	9K	5E	R1072	6G	7F
C1040	6J	6F	CR1103	9N	7A				R1075	9G	6E
C1048	4M	8E	CR1104	9P	7A	R1017	5E	6H	R1101	6P	5B
C1050	6F	6F	CR1105	7N	7A	R1018	7D	5J	R1102	6P	5B
C1051	7E	7D	CR1106	7P	7A	R1019	6D	6J	R1129	3P	8D
C1052	6F	6E	CR1110	7M	5C	R1020	2E	8J			
C1062	9F	7F	CR1113	8N	7B	R1021	6E	6J	LR1060	9K	6E
C1065	5L	6E	CR1114	8N	7B	R1022	2F	7H			
C1066	7F	7H	CR1115	7N	7A	R1023	3G	8H	T1020	6D	6J
C1067	9E	7E	CR1116	7N	7B	R1024	2H	8H	T1050	6F	6G
C1071	6H	7F	CR1121	6P	7D	R1025	2G	8H	T1060	5M	6C
C1072	7H	7F	CR1122	5P	7D	R1027	2N	8J			
C1075	8J	6E	CR1123	5P	7D	R1028	3N	8E	U1029	3P	8E
C1101	10M	6B	CR1124	5P	8D	R1029	2P	8F	U1030	3K	8G
C1102	10P	6A	CR1131	5P	8D	R1030	6H	7F	U1062	8G	7E
C1110	9N	6B	CR1132	5P	8D	R1031	4M	8F	U1040	4N	8E
C1111	9N	6A				R1032	4L	8G	U1062A	8H	7E
C1112	8P	7A	F1101	9P	6B	R1033	5L	8G	U1062B	9H	7E
C1113	8P	8B	F1102	9P	6A	R1034	3L	8G	U1062C	9F	7E
C1114	8P	8C				R1035	4M	8F	U1062D	9F	7E
C1115	7P	8C	J231B	5D	5H	R1036	4L	8G	U1064	8H	7E
C1116	7P	8B	J232B	9P	5A	R1037	3L	8H	U1064A	9G	7E
C1120	5P	8D	J233B	3P	8D	R1040	5H	7F	U1064B	9H	7E
C1130	5P	8D	J234B	7P	7B	R1041	6H	6F	U1066	8J	7E
C1132	5P	8C	J301	6P	8C	R1042	3H	7G	U1066A	8J	7E
			J302	6P	5B	R1044	4M	8E	U1066B	9J	7E
			J303	9P	5B	R1045	4M	8E			
CR1022	2E	7H				R1046	5N	8E	VR1020	3G	8H
CR1023	2H	8H	L1110	9N	6A	R1048	6H	6F	VR1062	7G	7G
CR1028	3N	8F	L1113	9P	8A	R1050	5G	5F			
CR1030	5G	6F	L1114	8P	8A	R1060	9K	6D	W1021	7D	7J
CR1034	3L	7G	L1115	7P	7C	R1061	7G	7G	W1022	6D	7H
CR1035	5L	8H	L1116	7P	8A	R1062	8F	7E	W1050	6G	6F
CR1040	6H	6F				R1063	9F	7E	W1060	6L	6D

CHASSIS MOUNTED PARTS

CIRCUIT NUMBER	SCHEM LOCATION	BOARD LOCATION	CIRCUIT NUMBER	SCHEM LOCATION	BOARD LOCATION	CIRCUIT NUMBER	SCHEM LOCATION	BOARD LOCATION	CIRCUIT NUMBER	SCHEM LOCATION	BOARD LOCATION
F90	5A	CHASSIS	P206	6A	CHASSIS	P233	3S	CHASSIS	S1020	5D	CHASSIS
P204	5A	CHASSIS	P207	7A	CHASSIS	P234	7S	CHASSIS			
P205	6A	CHASSIS	P231	5D	CHASSIS	S90	6A	CHASSIS			
			P232	9S	CHASSIS						

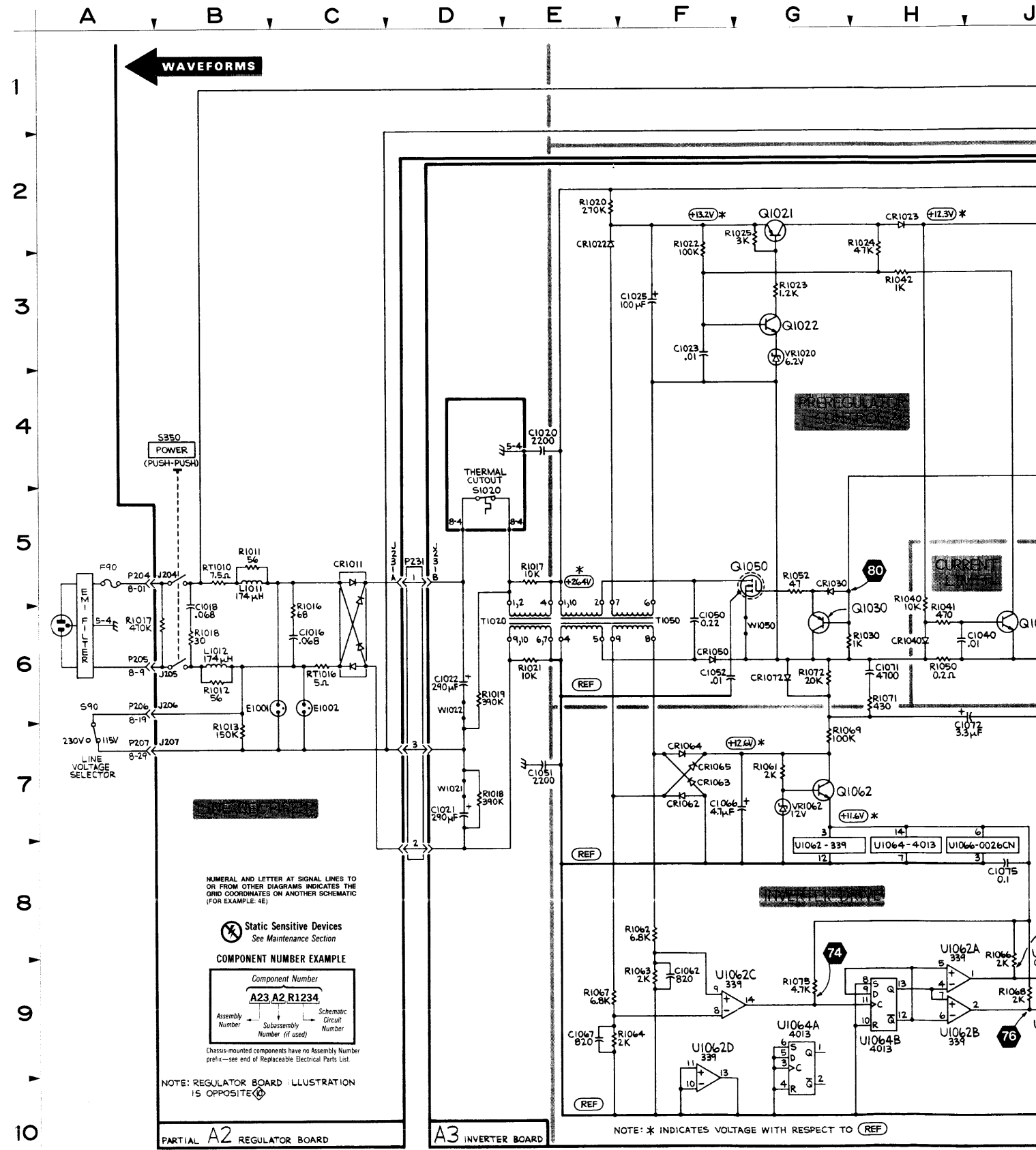

SCHEM LOCATION	BOARD LOCATION
5B	2A
6C	2C
4B	3A
1N	3C

SCHEM LOCATION	BOARD LOCATION
9E	7E
6L	6E
8J	6E
9E	7E
9J	6E
7G	7G
9K	6D
6H	7F
9G	6E
6P	5B
6P	5B
3P	8D

9K	6E
6D	6J
6F	6G
5M	6C
3P	8E
3K	8G
4N	7E
8G	8E
9H	7E
9F	7E
8H	7E
9G	7E
9H	7E
8J	7E
8J	7E
9J	7E

3G	8H
7G	7G
7D	7J
6D	7H
6G	6F
6L	6D

SCHEM LOCATION	BOARD LOCATION
5D	CHASSIS

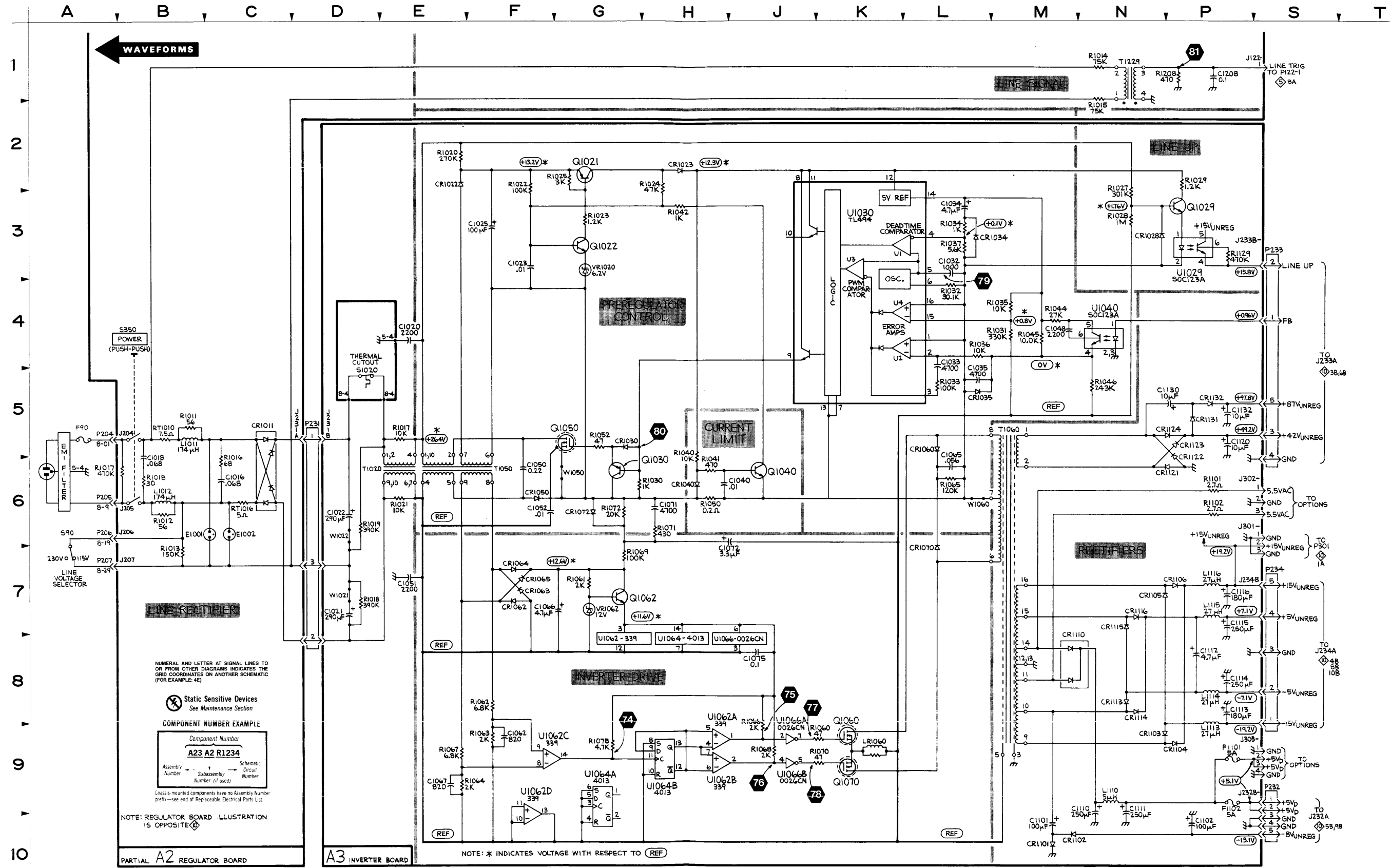

2445

3829-80

LOW-VOLTAGE POWER SUPPLY 9

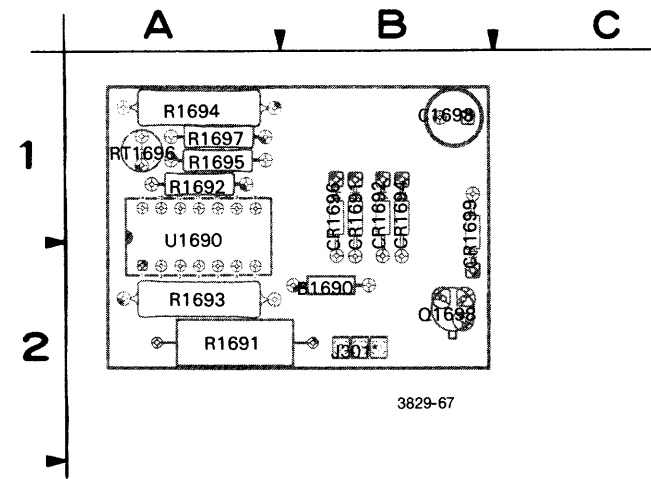
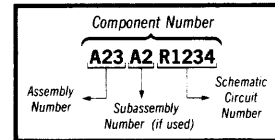

Figure 9-13. A10—Fan Motor board.

Static Sensitive Devices
See Maintenance Section

COMPONENT NUMBER EXAMPLE



Chassis-mounted components have no Assembly Number prefix—see end of Replaceable Electrical Parts List.

* LABELED ON SOME BOARDS AS "P" VICE "J".

ALL COMPONENTS MOUNTED ON A10—FAN MOTOR BOARD ARE SHOWN ON SCHEMATIC DIAGRAM

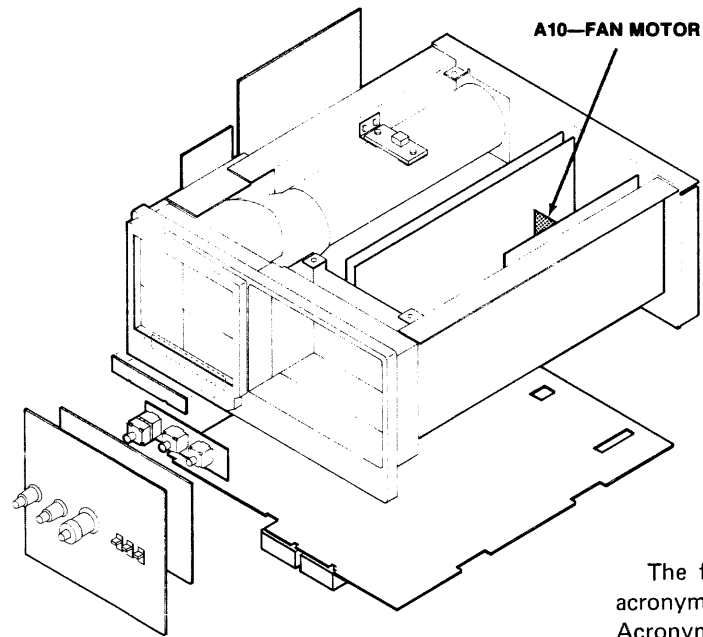

ACRONYM DICTIONARY

The following listing explains some of the less obvious acronyms and signal labels used on this schematic. Acronyms and labels not shown in this listing may be included in the circuit descriptions (Section 3) and should be obvious if a little thought is given to the intended circuit function.

FB . . . feedback
+5VD . . . +5 V digital

LOW-VOLTAGE REGULATORS AND FAN DRIVE DIAGRAM



ASSEMBLY A2											
CIRCUIT NUMBER	SCHEM LOCATION	BOARD LOCATION	CIRCUIT NUMBER	SCHEM LOCATION	BOARD LOCATION	CIRCUIT NUMBER	SCHEM LOCATION	BOARD LOCATION	CIRCUIT NUMBER	SCHEM LOCATION	BOARD LOCATION
C1220	2M	2D	CR1351	9H	4J	R1223	1G	4D	R1353	8J	2J
C1226	2F	2D	CR1376	7J	1F	R1226	2F	3D	R1354	8J	2J
C1240	3M	2D				R1227	2G	2D	R1355	8J	2J
C1245	3H	3E	F1330	10F	2E	R1228	2G	3D	R1357	8H	3J
C1246	3H	2E				R1229	1F	3D	R1358	8H	3J
C1260	3M	2D	J121	2P	2E	R1240	2J	3F	R1359	8H	3J
C1261	4J	3F	J122	3P	2F	R1241	2J	4E	R1370	7H	3G
C1270	6C	3G	J201	4P	1D	R1242	2J	4E	R1372	7H	2G
C1272	6B	3G	J202	4P	1D	R1243	2J	4E	R1374	7H	2G
C1274	6B	3F	J203	5P	1G	R1244	2G	4E	R1376	7J	2G
C1280	5M	2E	J232A	5B	1J	R1246	3G	3E	R1378	6K	2G
C1290	5E	2H	J232A	9B	1J	R1247	3H	2D	R1400	4D	3H
C1291	5F	2H	J233A	3B	3F	R1248	3H	3E	R1402	7D	4H
C1300	7M	2E	J233A	6B	3F	R1249	2G	3E			
C1330	9M	2F	J234A	10B	3H	R1261	4K	3F	TP201	5F	2H
C1331	9F	3J	J234A	4B	3H	R1262	4K	2F			
C1350	8M	2F	J234A	8B	3H	R1264	3K	3F	U1260	3J	4F
C1357	8H	2J				R1270	7B	3F	U1270A	6L	3J
C1374	7J	2G	L1402	7D	4H	R1273	6C	3G	U1270B	7L	3J
C1400	5D	3H				R1274	6C	3G	U1270C	9F	3J
C1402	7D	4H	P251	6S	1H	R1280	5M	3G	U1270D	8H	3J
						R1281	5M	3G	U1270	5D	3J
CR1220	2H	3D	Q1220	1H	4E	R1282	5L	2G	U1281A	2F	3D
CR1221	2N	2D	Q1221	1G	4D	R1283	4K	4F	U1281B	3H	3D
CR1241	3J	3E	Q1222	1F	3D	R1284	5L	2G	U1281	5C	3D
CR1242	3H	3E	Q1223	1F	4D	R1285	6L	2G	U1290	5E	2J
CR1243	3N	2E	Q1240	2K	4E	R1286	5L	2G	U1300A	5L	2H
CR1244	2G	3D	Q1241	2J	4E	R1291	5F	2H	U1300B	6L	2H
CR1260	3J	4F	Q1243	2H	3E	R1292	5F	2H	U1300C	5F	2H
CR1261	4N	2E	Q1245	3H	3E	R1293	6F	2H	U1300D	5J	2H
CR1262	3J	3F	Q1280	5M	4G	R1300	7M	3G	U1300	5D	2H
CR1263	4J	3F	Q1281	5L	4G	R1301	7M	3G	U1330	10F	4J
CR1264	4K	3F	Q1300	7M	4H	R1302	7L	3H	U1371A	3J	4F
CR1281	5K	2G	Q1301	7L	4H	R1304	7L	3H	U1371B	4K	3F
CR1282	5K	2G	Q1351	9K	2J	R1305	7L	3H	U1371C	7C	3F
CR1283	5N	2F	Q1354	8J	2J	R1306	6L	3H	U1371D	7J	3F
CR1300	6K	2H	Q1370	7H	3G	R1307	7K	3H	U1371	6D	3F
CR1301	7K	3H	Q1376	7K	1F	R1309	7K	4H			
CR1302	7K	3H				R1331	9G	3J	VR1293	5G	2H
CR1303	7M	2F	R1204	7H	3G	R1332	9G	3J			
CR1330	10F	4J	R1212	1F	4D	R1333	9F	3J	W251	8S	1H
CR1331	9N	2G	R1220	1H	3E	R1334	9F	3J			
CR1332	9F	4J	R1221	1G	4D	R1351	9H	4J			
CR1334	7N	2G	R1222	1G	4D	R1352	8K	2J			

Partial A2 also shown on diagram 9.

ASSEMBLY A10											
CIRCUIT NUMBER	SCHEM LOCATION	BOARD LOCATION	CIRCUIT NUMBER	SCHEM LOCATION	BOARD LOCATION	CIRCUIT NUMBER	SCHEM LOCATION	BOARD LOCATION	CIRCUIT NUMBER	SCHEM LOCATION	BOARD LOCATION
B1690	2C	2B	CR1696	2D	1B	R1691	3C	2A	RT1696	3E	1A
C1698	1E	1B	CR1699	1E	1B	R1692	2C	1A			
CR1691	2D	1B	J301	1B	2B	R1693	1B	2A	U1690A	2D	1A
CR1692	2D	1B				R1694	1D	1A	U1690B	2B	1A
CR1694	2D	1B	Q1698	1D	2B	R1695	2E	1A	U1690C	2C	1A
						R1697	2E	1A	U1690D	2C	1A

CHASSIS MOUNTED PARTS											
CIRCUIT NUMBER	SCHEM LOCATION	BOARD LOCATION	CIRCUIT NUMBER	SCHEM LOCATION	BOARD LOCATION	CIRCUIT NUMBER	SCHEM LOCATION	BOARD LOCATION	CIRCUIT NUMBER	SCHEM LOCATION	BOARD LOCATION
W301	1A	CHASSIS	P301	1A	CHASSIS						

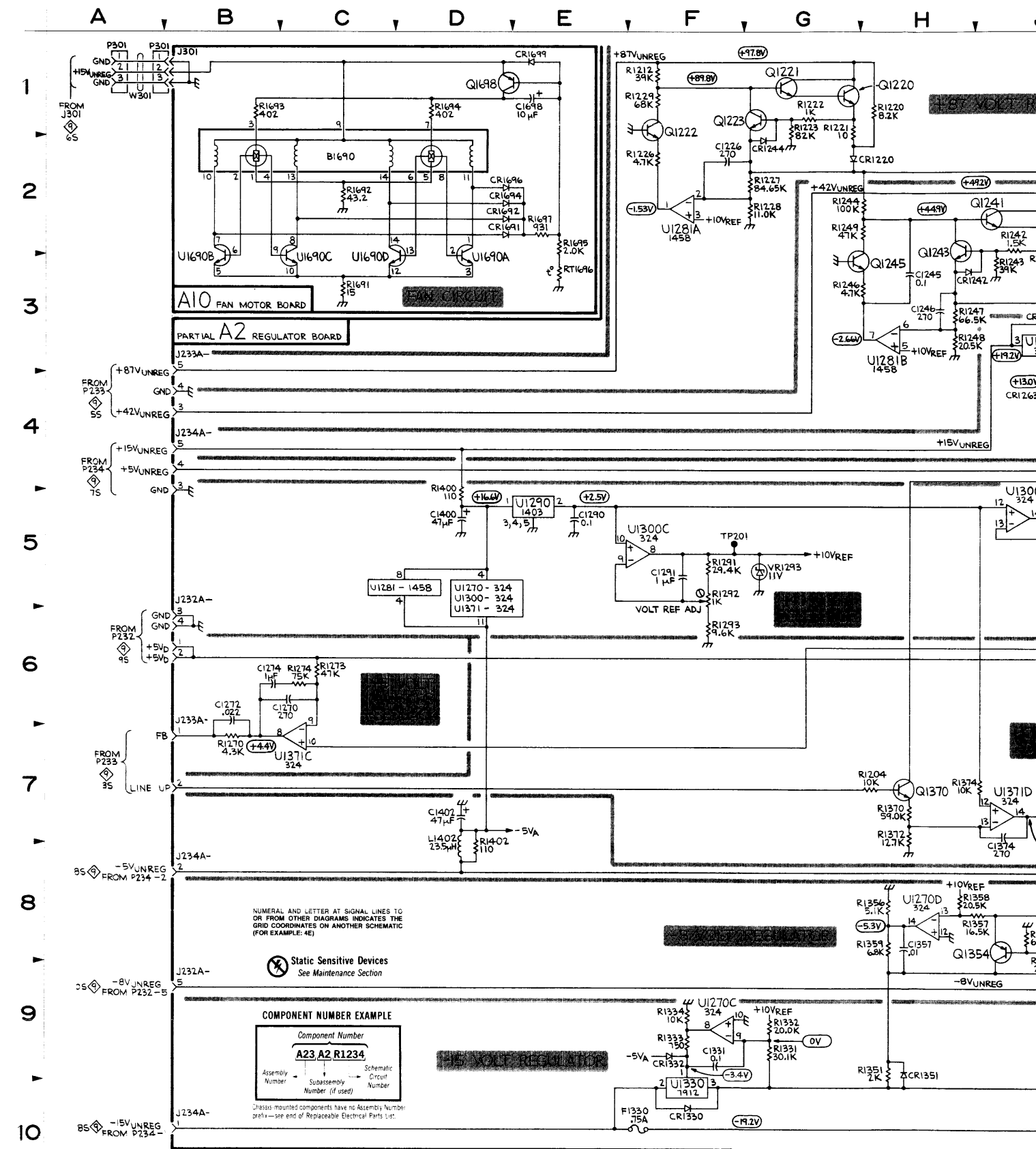

SCHEM LOCATION	BOARD LOCATION
----------------	----------------

8J	2J
8J	2J
8H	3J
8H	3J
8H	3J
7H	3G
7H	2G
7J	2G
6K	2G
4D	3H
7D	4H

5F	2H
----	----

3J	4F
6L	3J
7L	3J
9F	3J
8H	3J
5D	3J
2F	3D
3H	3D
5C	3D
5E	2J
5L	2H
6L	2H
5F	2H
5J	2H
5D	2H
10F	4J
3J	3F
4K	3F
7C	3F
7J	3F
6D	3F

5G	2H
8S	1H

SCHEM LOCATION	BOARD LOCATION
----------------	----------------

3E	1A
2D	1A
2B	1A
2C	1A
2C	1A

SCHEM LOCATION	BOARD LOCATION
----------------	----------------

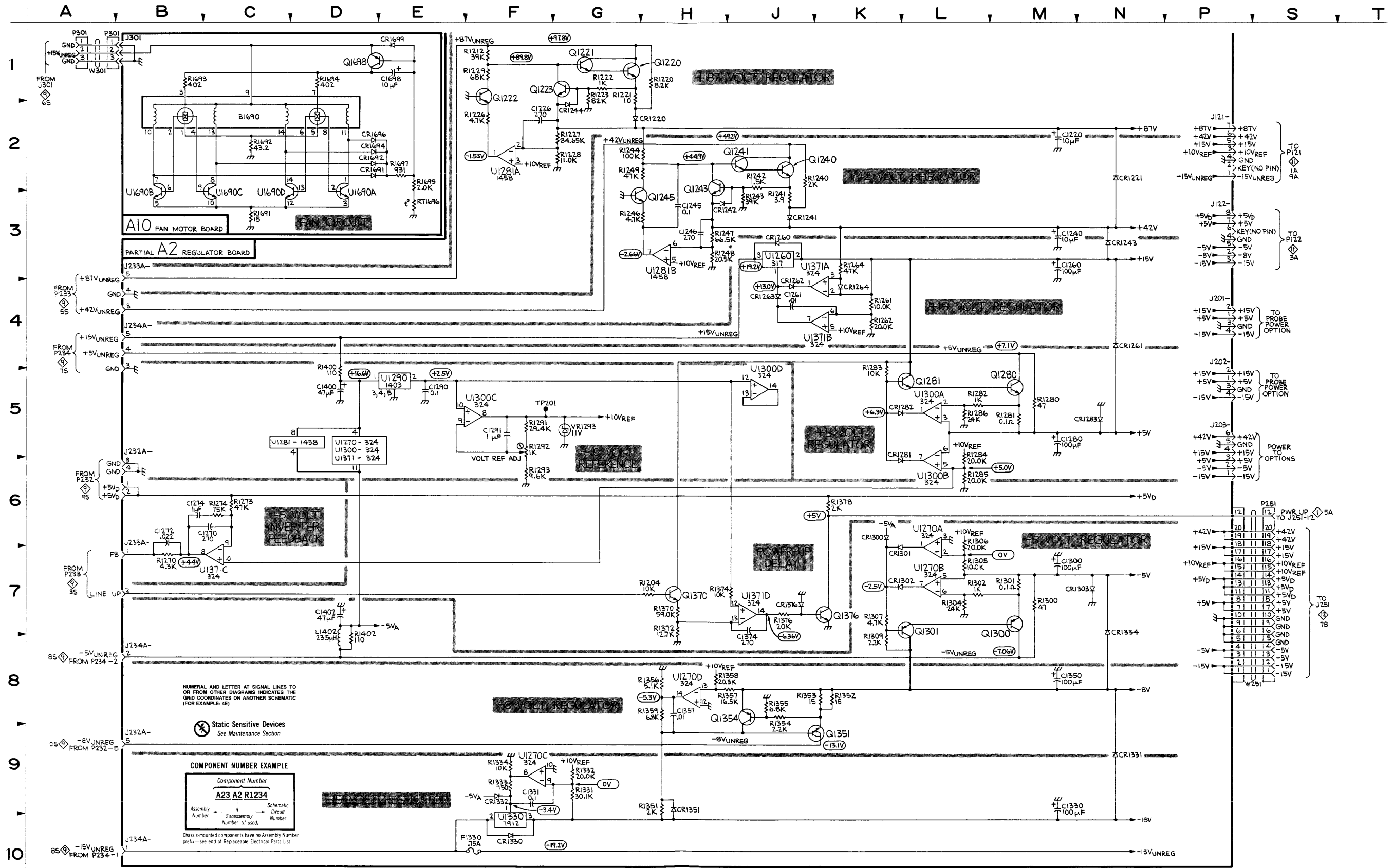

POWER DISTRIBUTION A DIAGRAM



ASSEMBLY A1											
CIRCUIT NUMBER	SCHEM LOCATION	BOARD LOCATION	CIRCUIT NUMBER	SCHEM LOCATION	BOARD LOCATION	CIRCUIT NUMBER	SCHEM LOCATION	BOARD LOCATION	CIRCUIT NUMBER	SCHEM LOCATION	BOARD LOCATION
C102	8B	6D	C850	7M	7F	L740	7H	6D	U170	5L	2E
C106	6A	5D	C933	2M	8G	L743	3H	6D	U200	5C	4D
C107	7B	5D	C938	7M	9G	L938	7K	6J	U300	5D	2B
C108	8B	6D	C940	7M	9H	L973	8M	9K	U350	5L	8B
C113	4B	6D	C943	3M	9H				U400	5E	5E
C114	3B	5D	C958	3M	7K	LR101	6A	5C	U450	2M	3F
C119	7B	5C	C966	1M	9K	LR107	6C	6D	U500	5E	2G
C120	2B	5E	C973	8M	9K	LR201	6B	4C	U600	5F	6H
C121	2B	5E	C988	7K	6K	LR218	7C	3D	U650	5G	3J
C125	4A	5C	C990	2M	8K				U700	5H	7D
C207	8A	4C				P121	2A	4J	U800	5J	7F
C218	7C	3D	CR107	7B	4H	P121	9A	4J	U850	6L	8F
C219	7B	3D	CR807	4J	7F	P122	3A	4H	U860	6L	6F
C220	2C	3D	CR811	2K	7F				U900	5H	8H
C221	2C	3D	CR987	4K	8K	Q700	1G	9C	U910	2G	9F
C225	4B	3C							U950	5K	8K
C307	7D	3B	J119	8S	4H	R120	2B	5E	U975	3L	6K
C325	3D	3C	J191	10S	8K	R125	4B	6D	U980	3L	6K
C336	3D	1C	J191	1S	8K	R220	2B	3C			
C415	7M	4F	J411	3S	1K	R225	4B	3C	VR125	4A	6D
C458	2M	4F	J511	10A	1D	R700	1G	9C	VR225	4B	3C
C480	2M	2J	J511	6S	1D	R701	1F	9C			
C521	7M	2H	J512	6S	1H	R702	2F	9D	W101	3A	9B
C675	3M	3H				R811	2K	7G	W102	3A	4K
C710	1G	9D	L101	8A	6D	R951	10P	9J	W103	3A	7G
C722	3H	6D	L107	7B	6D				W104	3A	3K
C723	3H	6D	L113	3B	6D	U100	5B	5D	W105	4A	5F
C731	10C	8E	L219	7B	3D	U110	2B	6B	W109	4A	9L
C733	2H	7E	L307	7D	3B	U120	2B	6C	W121	10A	4J
C738	8G	6E	L325	3D	3C	U130	2B	6C	W121	1A	4J
C740	7H	6D	L336	3D	1C	U140	3L	7B	W122	8A	4H
C810	2M	7F	L521	7E	2H	U150	3L	7C			
C811	3M	7F	L733	2H	6E	U160	2C	2D			
C819	7M	8E	L738	8G	6E	U165	4L	2F			

Partial A1 also shown on diagrams 4, 5, 6 and 8.

ACRONYM DICTIONARY

The following listing explains some of the less obvious acronyms and signal labels used on this schematic. Acronyms and labels not shown in this listing may be included in the circuit descriptions (Section 3) and should be obvious if a little thought is given to the intended circuit function.

- GND C . . . virtual ground "C"
- GND R . . . virtual ground "R"
- GND S . . . virtual ground "S"
- +5VD . . . +5 V digital
- +5V1 . . . +5 V decoupled (1)
- +5V2 . . . +5 V decoupled (2)
- 5V1 . . . -5 V decoupled (1)
- 5V2 . . . -5 V decoupled (2)
- 5V3 . . . -5 V decoupled (3)
- 5V4 . . . -5 V decoupled (4)
- 8V1 . . . -8 V decoupled (1)
- 8V2 . . . -8 V decoupled (2)
- +15V1 . . . +15 V decoupled (1)
- 15V2 . . . -15 V decoupled (2)

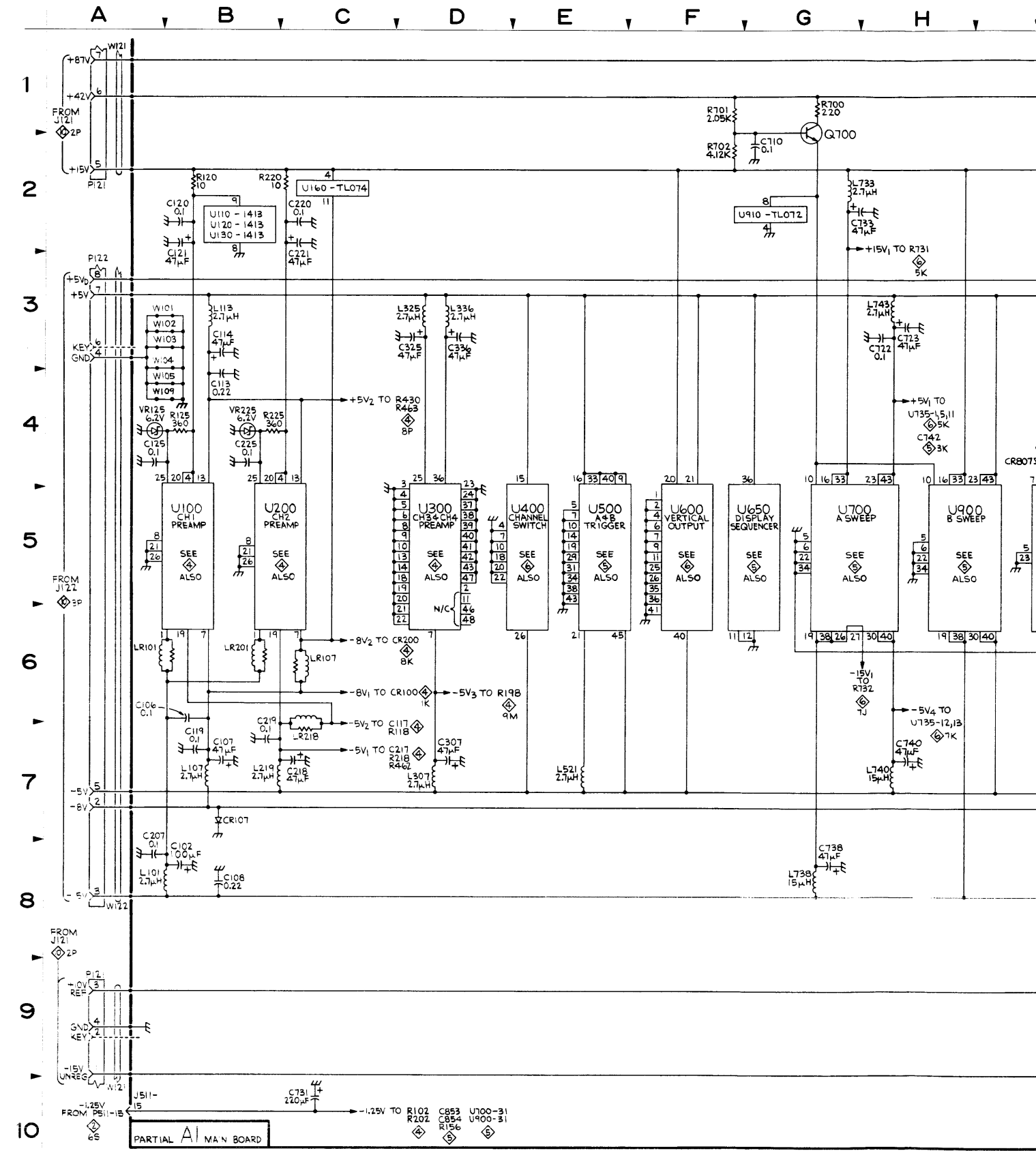

SCHEM LOCATION	BOARD LOCATION
5L	2E
5C	4D
5D	2B
5L	8B
5E	5E
2M	3F
5E	2G
5F	6H
5G	3J
5H	7D
5J	7F
6L	8F
6L	6F
5H	8H
2G	9F
5K	8K
3L	6K
3L	6K
4A	6D
4B	3C
3A	9B
3A	4K
3A	7G
3A	3K
4A	5F
4A	9L
10A	4J
1A	4J
8A	4H

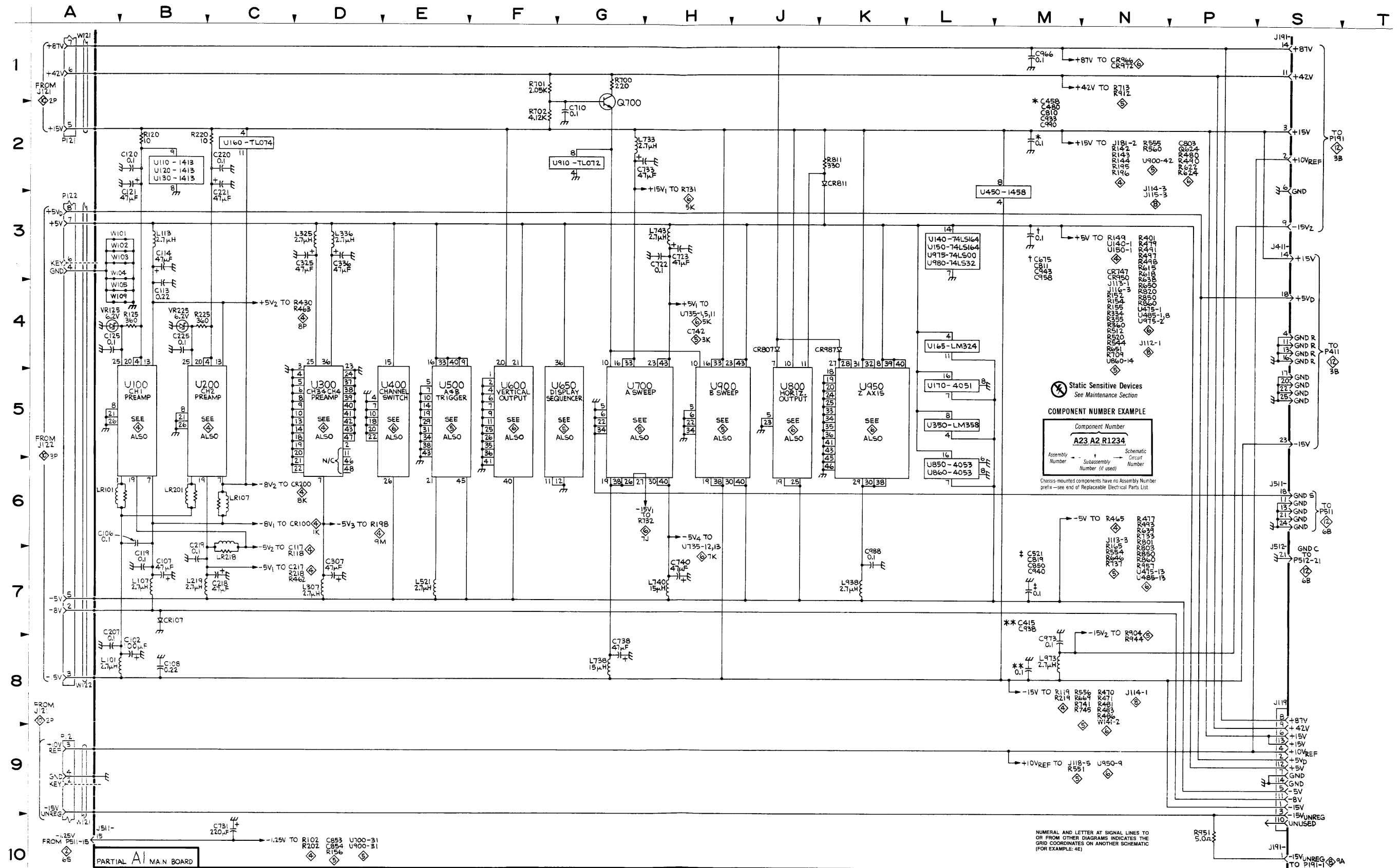

2445

3829-82

POWER DISTRIBUTION A

ACRONYM DICTIONARY

The following listing explains some of the less obvious acronyms and signal labels used on this schematic. Acronyms and labels not shown in this listing may be included in the circuit descriptions (Section 3) and should be obvious if a little thought is given to the intended circuit function.

GND C . . . virtual ground "C"
GND R . . . virtual ground "R"
GND S . . . virtual ground "S"
+5VD . . . +5 V digital
-15V2 . . . -15 V decoupled (2)
+87V1 . . . +87 V decoupled (1)

POWER DISTRIBUTION B DIAGRAM

12

ASSEMBLY A4											
CIRCUIT NUMBER	SCHEM LOCATION	BOARD LOCATION	CIRCUIT NUMBER	SCHEM LOCATION	BOARD LOCATION	CIRCUIT NUMBER	SCHEM LOCATION	BOARD LOCATION	CIRCUIT NUMBER	SCHEM LOCATION	BOARD LOCATION
C2830	4C	1C	C2990	4C	3F	U2860	4G	2D	U2960	4G	2E
C2835	4C	2C				U2865	4G	2E	U2965	5H	3E
C2851	4C	1D	P411	3B	1A	U2870	4H	2E	U2970	5H	3E
C2855	4C	2D				U2880	4H	1E	U2980	5H	2E
C2860	4C	2D	R2805	4C	2B	U2885	4H	2F	U2985	4G	3E
C2885	4C	2E				U2890	4H	2E	U2990	5H	3E
C2901	4C	2B	U2800	4D	2B	U2900	5H	2A	U2995	5H	4E
C2913	5B	4B	U2805	4D	2B	U2905	4E	3A			
C2926	4C	3C	U2810	4H	2A	U2910	3D	3A	VR2805	4C	2B
C2940	3B	4C	U2820	3C	2A	U2920	4E	3B			
C2950	4C	4D	U2830	4H	1C	U2930	4F	3D	W411	5B	1A
C2960	4C	2E	U2835	4H	2C	U2935	4G	3C	W2851	4B	1D
C2970	4C	3D	U2850	4H	1D	U2940	5H	4C	W2913	5B	4B
C2980	4C	2F	U2855	4H	2D	U2950	5H	4D			

Partial A4 also shown on diagram 7.

ASSEMBLY A5											
CIRCUIT NUMBER	SCHEM LOCATION	BOARD LOCATION	CIRCUIT NUMBER	SCHEM LOCATION	BOARD LOCATION	CIRCUIT NUMBER	SCHEM LOCATION	BOARD LOCATION	CIRCUIT NUMBER	SCHEM LOCATION	BOARD LOCATION
C2041	8C	1C	C2637	7B	3D	U2134	8H	1B	U2496	8G	3J
C2188	8C	1H	C2642	10C	4D	U2162	8F	2J	U2556	8J	3J
C2217	9B	2E	C2734	9C	4F	U2178	8F	1J	U2580	8H	4J
C2218	9B	3D				U2214	9E	2D	U2596	9F	4J
C2221	10C	2C	J251	7B	2D	U2234	8D	2B	U2634	7D	3D
C2223	10B	2C				U2308	9F	2F	U2656	8H	4G
C2240	8C	1A	P511	6B	4C	U2335	8E	3D	U2668	9H	4G
C2328	10C	4E	P512	6B	4H	U2362	8F	3J	U2770	9H	3J
C2346	8C	3D				U2378	8F	2J			
C2354	8B	1C	R2608	6L	3A	U2408	8E	3A	W511	6B	4C
C2440	10C	4E				U2418	8E	3B	W512	7B	4H
C2475	8C	4J	TP508	7L	4K	U2427	7D	3C	W2143	7L	1A
C2485	8C	3K				U2435	7D	3E	W2526	6L	4A
C2527	7C	4D	U2034	8H	2B	U2456	8H	3B			
C2575	8C	4H	U2092	8E	1G	U2468	8J	4J			
C2586	9C	3K	U2108	8H	2G	U2480	8H	4K			

Partial A5 also shown on diagrams 1 and 2.

ASSEMBLY A6											
CIRCUIT NUMBER	SCHEM LOCATION	BOARD LOCATION	CIRCUIT NUMBER	SCHEM LOCATION	BOARD LOCATION	CIRCUIT NUMBER	SCHEM LOCATION	BOARD LOCATION	CIRCUIT NUMBER	SCHEM LOCATION	BOARD LOCATION
P651	6M	3F	U3300	8N	4B	U3375	8N	3D	W652	10M	2A
P652	6M	2A	U3325	8N	3C						
			U3350	8N	2F	W651	6M	3F			

Partial A6 also shown on diagram 3.

ASSEMBLY A9											
CIRCUIT NUMBER	SCHEM LOCATION	BOARD LOCATION	CIRCUIT NUMBER	SCHEM LOCATION	BOARD LOCATION	CIRCUIT NUMBER	SCHEM LOCATION	BOARD LOCATION	CIRCUIT NUMBER	SCHEM LOCATION	BOARD LOCATION
C1909	1C	3A	R1933	1B	4A	U1956	2C	4C			
P191	3B	4B	U1890	2C	2E	W1909	3B	3A			

Partial A9 also shown on diagrams 6 and 8.

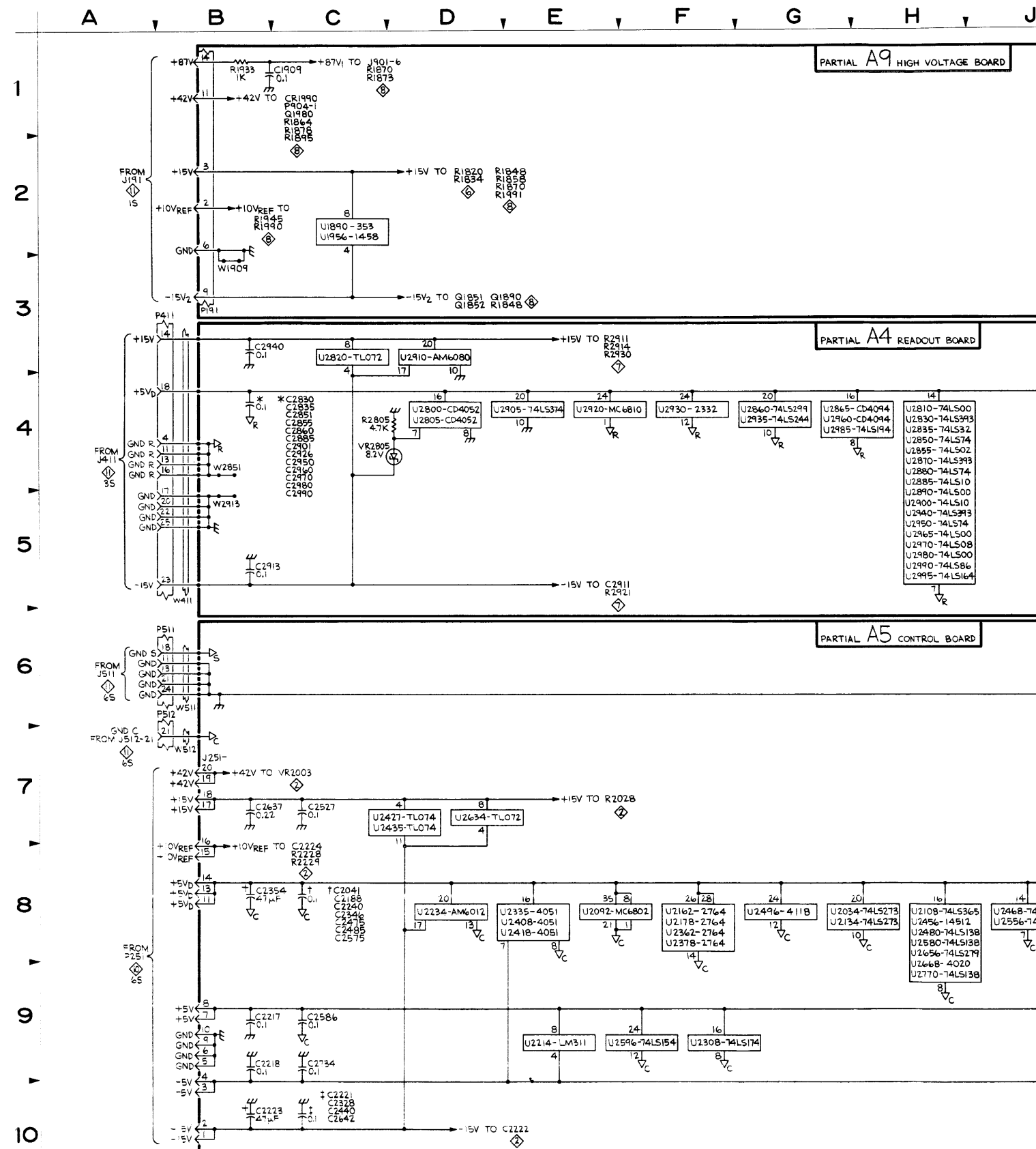

SCHEM LOCATION	BOARD LOCATION
4G	2E
5H	3E
5H	3E
4G	2E
5H	3E
5H	4E
4C	2B
5B	1A
4B	1D
5B	4B

SCHEM LOCATION	BOARD LOCATION
8G	3J
8J	3J
8H	4J
9F	3J
7D	4D
8H	4G
9H	4G
9H	3J
6B	4C
7B	4H
7L	1A
6L	4A

SCHEM LOCATION	BOARD LOCATION
10M	2A

SCHEM LOCATION	BOARD LOCATION

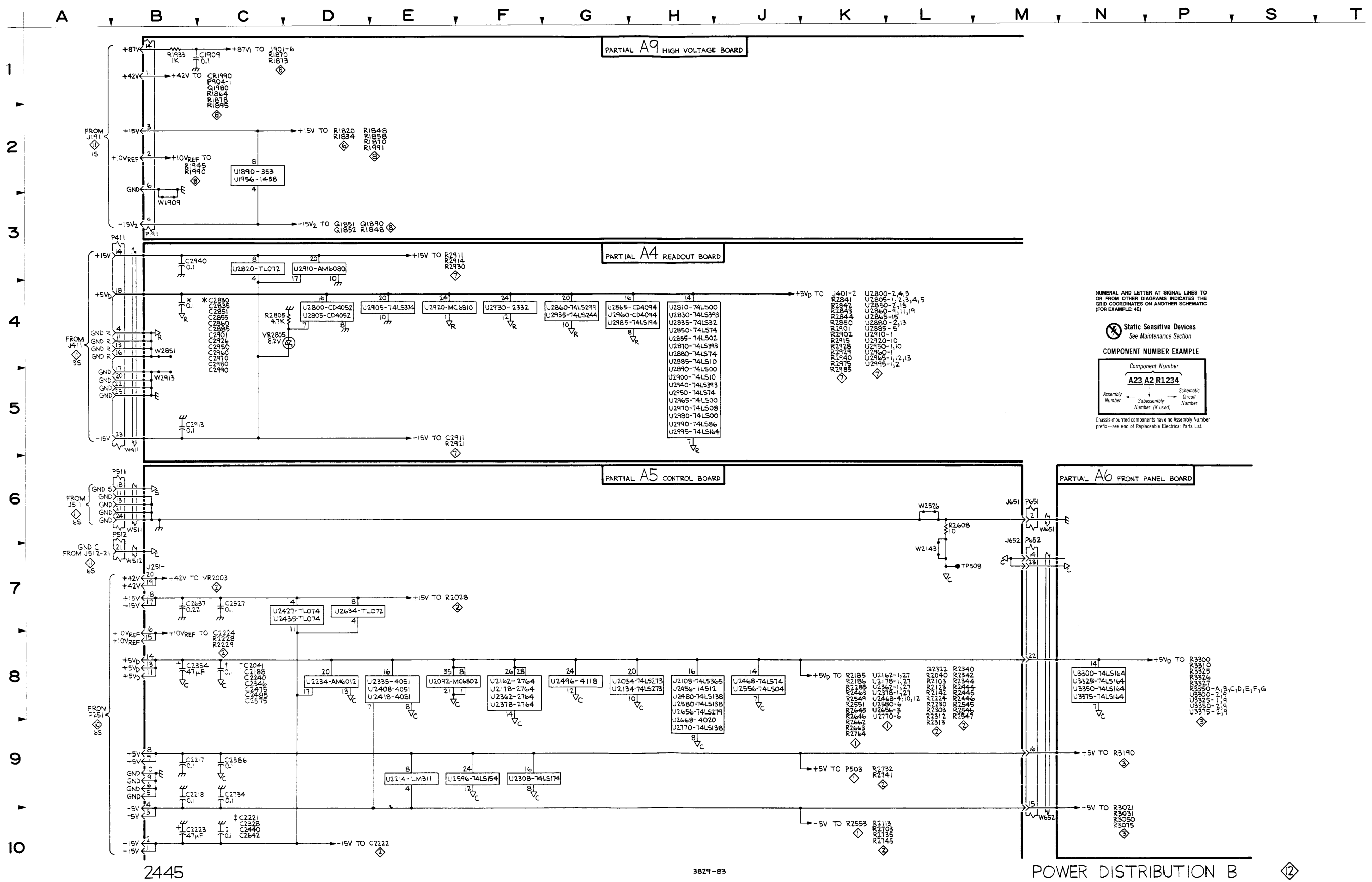

NUMERAL AND LETTER AT SIGNAL LINES TO OR FROM OTHER DIAGRAMS INDICATES THE GRID COORDINATES ON ANOTHER SCHEMATIC (FOR EXAMPLE: 4E)

Static Sensitive Devices
See Maintenance Section

COMPONENT NUMBER EXAMPLE

Component Number
A23 A2 R1234

Assembly Number Subassembly Number (if used) Schematic Circuit Number

Chassis mounted components have no Assembly Number prefix—see end of Replaceable Electrical Parts List.

2445

3829-83

POWER DISTRIBUTION B

2445 Service

J110 A1 Test Connector		
Pin	Line Name	Schem
1	ATTN CLK	4
2	GND	4
3	CH4 POS	4
4	Unused	4
5	CH1 POS	4
6	GND	4
7	CH3 POS	4
8	CH2 POS	4

J/P/W121 A1 to A2		
Pin	Line Name	Schem
1	-15VUNREG	10,11
2	Key ^a	10,11
3	+10VREF	10,11
4	GND	10,11
5	+15V	10,11
6	+42V	10,11
7	+87V	10,11

J/P/W251 A2 to A5		
Pin	Line Name	Schem
1	-15V	10,12
2	-15V	10,12
3	-5V	10,12
4	-5V	10,12
5	GND	10,12
6	GND	10,12
7	+5V	10,12
8	+5V	10,12
9	GND	10,12
10	GND	10,12
11	+5V _D	10,12
12	PWR UP	1,10
13	+5V _D	10,12
14	+5V _D	10,12
15	+10VREF	10,12
16	+10VREF	10,12
17	+15V	10,12
18	+15V	10,12
19	+42V	10,12
20	+42V	10,12

J500 A5 to Options		
Pin	Line Name	Schem
1	A7	1
2	A15	1
3	A6	1
4	A14	1
5	MR	1
6	A13	1
7	A5	1
8	A12	1
9	A4	1
10	A11	1
11	A3	1
12	A10	1
13	GND C	1
14	A9	1
15	A2	1
16	A8	1
17	A1	1
18	A0	1
19	R/W	1
20	BD7	1
21	GND C	1
22	BD6	1
23	BD3	1
24	BD5	1
25	BD2	1
26	GND C	1
27	BD1	1
28	BD4	1
29	BD0	1
30	E	1
31	GND C	1
32	10MHZ	1
33	VMA	1
34	RESET	1

J502 A5 to Options		
Pin	Line Name	Schem
1	OEA35	2
2	OEACLK	2
3	GND C	2
4	OEAI/O	2
5	OEAC2	2
6	OEAC1	2
7	OEAC3	2

J/P/W512 A5 to A1		
Pin	Line Name	Schem
1	CONT DATA	2,4
2	ATTN STRB	2,4
3	ATTN CLK	1,4
4	CH2 PA CLK	1,4
5	CH1 PA CLK	1,4
6	A TRIG CLK	1,5
7	B TRIG CLK	1,5
8	A SWP CLK	1,5
9	B SWP CLK	1,5
10	DISP SEQ CLK	1,5
11	RO ON	2,5
12	RO DO	2,6
13	ROS 2	1,6
14	ROS 1	1,6
15	ROSFRAME	1,6
16	DAC MUX1 A0	2,4
17	TSO	2,5
18	DAC MUX1 A1	2,4
19	TRIG STAT	STRB 1,5
20	DAC MUX1 A2	2,4
21	GND C	11,12
22	DAC MUX1 INH	1,4
23	R/W DLYD	1,6
24	BD0	1,6
25	5MHZ	1,5
26	10MHZ	1,6

J118 A1 Test Connector		
Pin	Line Name	Schem
1	Unused	5
2	DLY REF 0	5
3	DLY REF 1	5
4	GND	5
5	+10VREF	5
6	ROR	5
7	Unused	5
8	GND	5

J/P/W122 A1 to A2		
Pin	Line Name	Schem
1	LINE TRIG	5,9
2	-8V	10,11
3	-15V	10,11
4	GND	10,11
5	-5V	10,11
6	Key ^a	10,11
7	+5V	10,11
8	+5V _D	10,11

J/P/W411 A4 to A1		
Pin	Line Name	Schem
1	ROB	5,7
2	ROR	5,7
3	ROA	5,7
4	GND R	11,12
5	ROS 2	6,7
6	SGA	5,7
7	ROSFRAME	6,7
8	ROS 1	6,7
9	R/W DLYD	6,7
10	RO DO	6,7
11	GND R	11,12
12	10 MHZ	6,7
13	GND R	11,12
14	+15V	11,12
15	BD0	6,7
16	GND R	11,12
17	GND	11,12
18	+5V _D	11,12
19	DLY REF 1	5,7
20	GND	11,12
21	DLY REF 0	5,7
22	GND	11,12
23	-15V	11,12
24	READOUT	HORIZ OUT 6,7
25	GND	11,12
26	READOUT	VERT OUT 6,7

J/P/W511 A5 to A1		
Pin	Line Name	Schem
1	CH1 PRB	2,4
2	CH2 OVL	2,4
3	CH4 PRB	2,4
4	CH3 PRB	2,4
5	CH1 OVL	2,4
6	CH2 PRB	2,4
7	CH4 POS	2,4
8	CH3 POS	2,4
9	CH2 POS	2,4
10	CH1 POS	2,4
11	GND	11,12
12	DAC MUX1 IN	2,4
13	GND	11,12
14	TRACE SEP	2,6
15	-1.25V	2,11
16	DLY REF 0	2,5
17	DLY REF 1	2,5
18	GND S	11,12
19	A TIM REF	2,5
20	B TIM REF	2,5
21	GND	11,12
22	HORIZ POS	2,6
23	S1	2,4
24	GND	11,12
25	A TRIG LVL	2,5
26	B TRIG LVL	2,5

J/P/W651 A6 to A5		
Pin	Line Name	Schem
1	DAC MUX1 IN	2,3
2	GND	12
3	HORIZ POS	2,3
4	+1.36V	2,3
5	-1.25V	2,3
6	DLY A	2,3
7	ΔA	2,3
8	ΔB	2,3
9	DLY B	2,3
10	HORIZ VAR	2,3
11	TRIG LEVEL	2,3
12	HOLDOFF	2,3
13	-1.25V	2,3
14	TRACE SEP	2,3
15	CH1 VAR	2,3
16	CH2 VAR	2,3
17	CH1 POS	2,3
18	CH2 POS	2,3
19	CH3 POS	2,3
20	CH4 POS	2,3

J119 A1 Test Connector		
Pin	Line Name	Schem
1	-15V	11
2	+5V _D	11
3	-15VUNREG	11
4	+10VREF	11
5	-5V	11
6	+15V	11
7	GND	11
8	+87V	11
9	+42V	11
10	Unused	11
11	-8V	11
12	+5V	11
13	+15V	11
14	GND	11

J/P191 A1 to A9		
Pin	Line Name	Schem
1	-15VUNREG	8,11
2	+10VREF	11,12
3	+15V	11,12
4	FOCUS	8
5	ASTIG	8
6	GND	11,12
7	VZOUT	6,8
8	VQOUT	6,8
9	-15V ₂	11,12
10	TRACE ROT	8
11	+42V	11,12
12	TRZ	6
13	QGAIN	6
14	+87V	11,12

A B C D E F G H J K L M N P S T

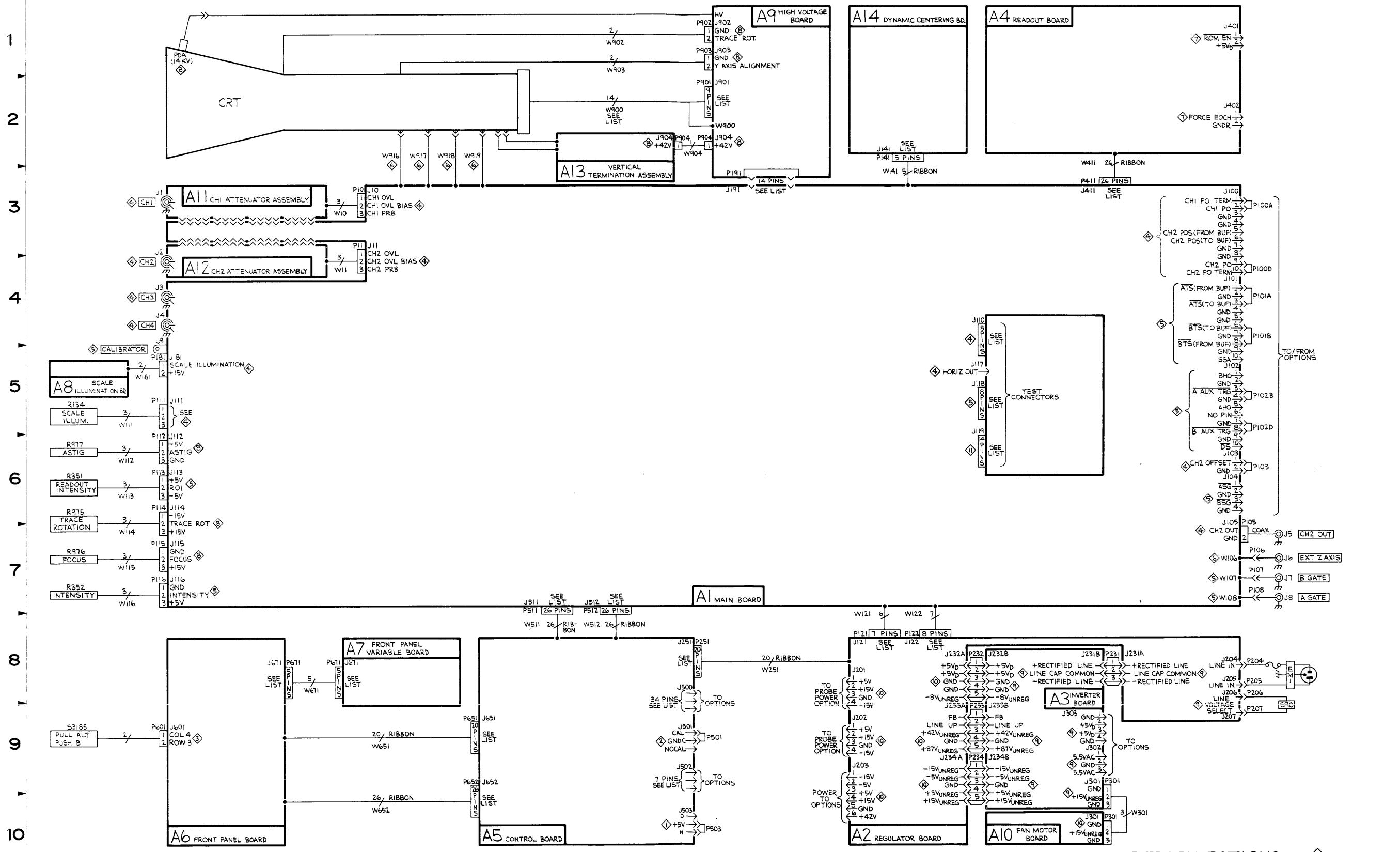

2445

3829-84

INTERCONNECTIONS



CHASSIS MOUNTED PARTS

CIRCUIT NUMBER	SCHEM NUMBER	SCHEM LOCATION	CIRCUIT NUMBER	SCHEM NUMBER	SCHEM LOCATION
F90	9	5A	P904	8	5P
J3	4	10A	R134	4	5N
J4	4	10A	R351	5	5A
J5	4	8T	R352	5	6A
J6	6	9A	R975	8	2B
J7	5	7S	R976	8	5B
J8	5	3S	R977	8	4B
			R996	8	3K
L90	8	2L	S90	9	6A
LR1313	8	5M	S1020	9	5D
LR1314	8	5M	S3185	3	5D
P111	4	4N	V900	8	2L
P112	8	3C			
P113	5	5A	W111	4	5N
P114	8	2C	W112	8	4B
P115	8	4C	W113	5	6A
P116	5	6A	W114	8	3B
P204	9	5A	W115	8	5B
P205	9	6A	W116	5	6A
P206	9	6A	W121	10	2S
P207	9	7A	W122	10	3S
P231	9	5D	W122	9	1S
P232	9	9S	W301	10	1A
P233	9	3S	W671	3	8N
P234	9	7S	W900	8	3M
P601	3	5D	W900	8	6J
P671	3	7N	W900	8	7J
P901	8	3M	W900	8	7M
P901	8	4J	W902	8	3J
P901	8	5M	W903	8	4M
P902	8	2J			
P903	8	4M			

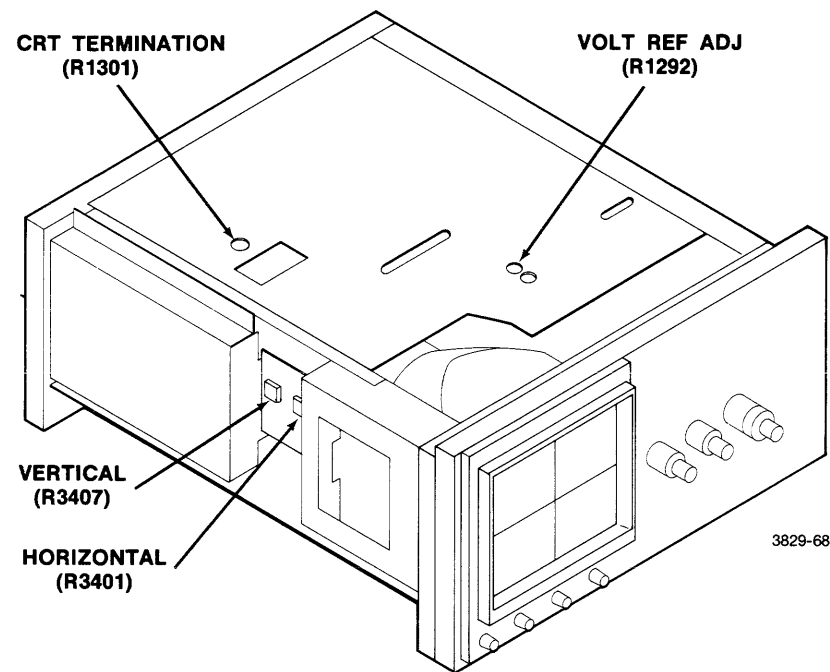

3829-68

A13—CRT TERMINATION, A14—DYNAMIC CENTERING, ADJUSTMENT LOCATIONS 1

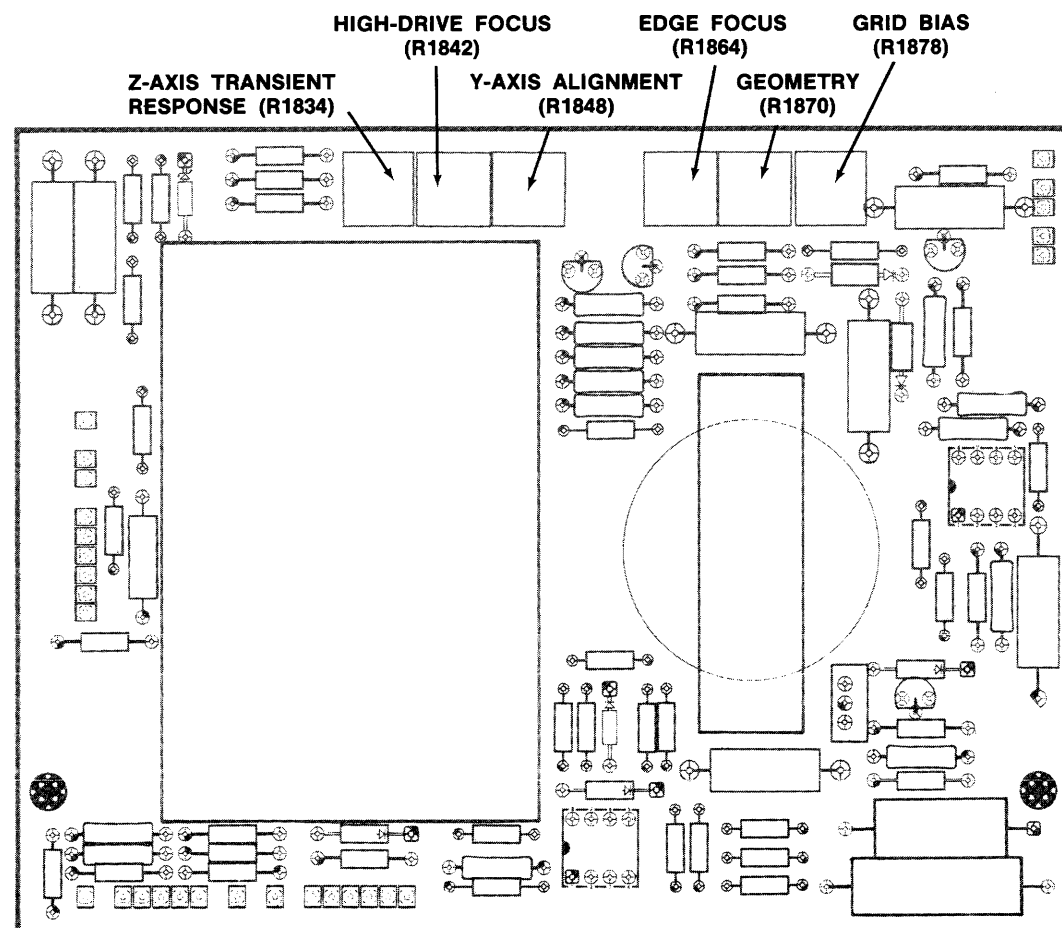

3829-69

A9—HIGH VOLTAGE, ADJUSTMENT LOCATIONS 2

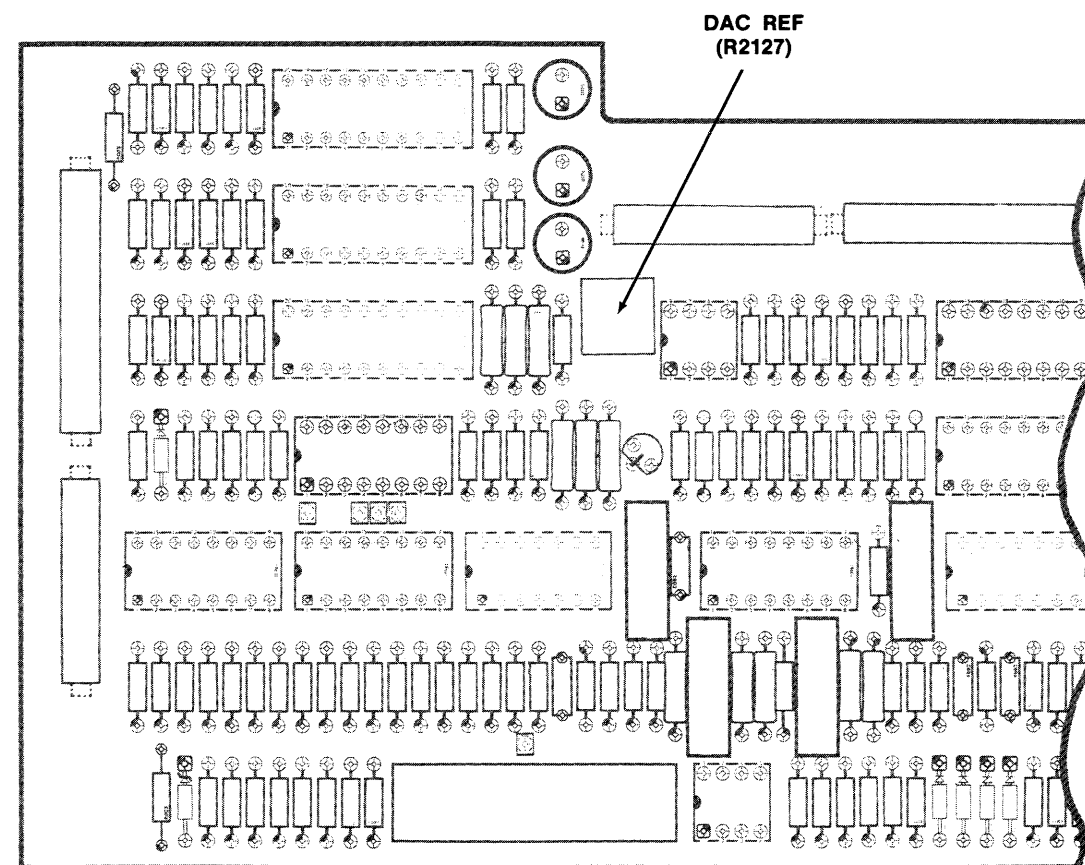

3829-70

A5—CONTROL, ADJUSTMENT LOCATIONS 3

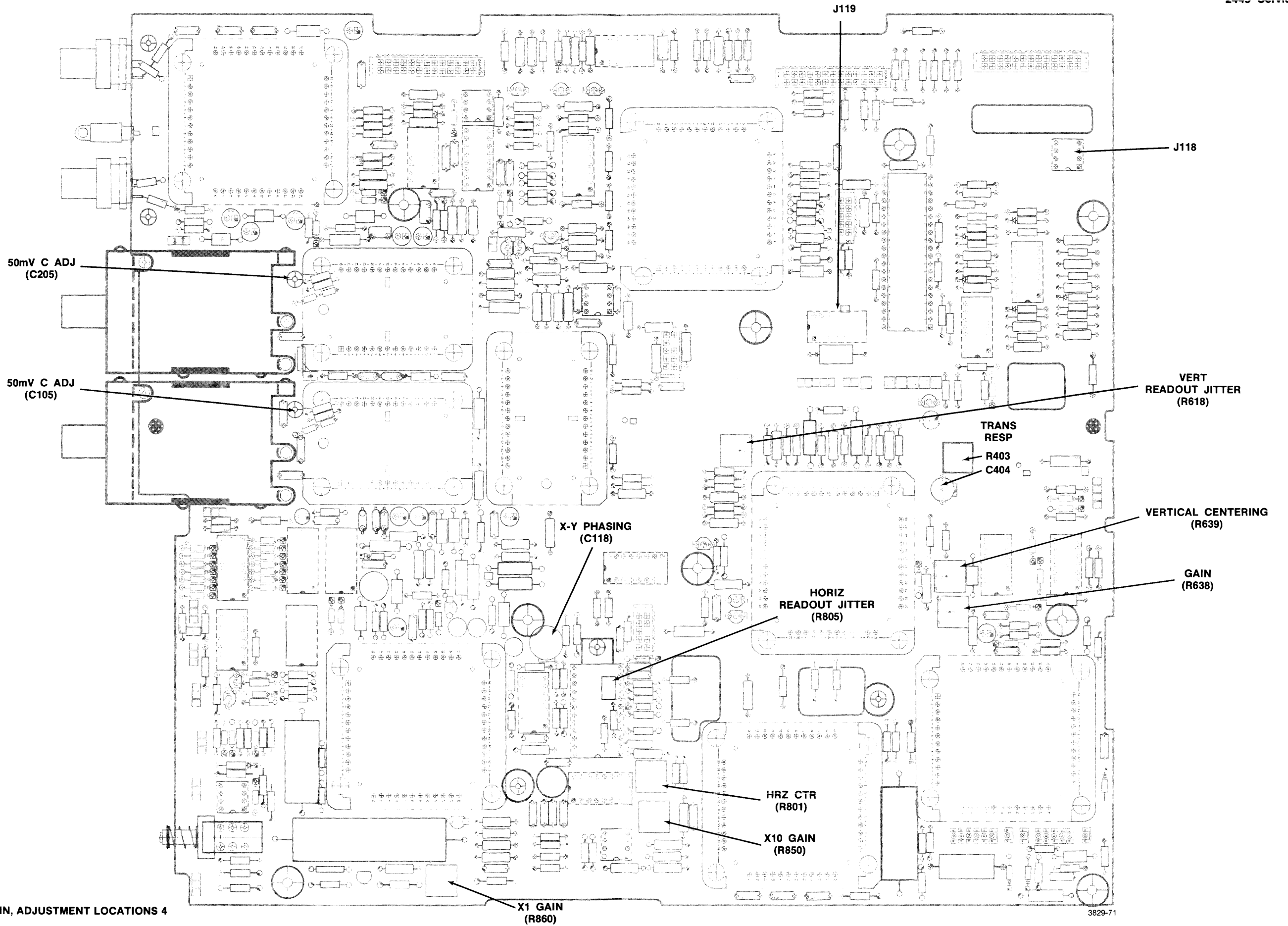

A1-MAIN, ADJUSTMENT LOCATIONS 4